

JVC

SERVICE MANUAL

MODEL
JR-S301
DC INTEGRATED RECEIVER



No. 2434
DEC. 1977

1. Specifications

Dimensions	: 166 mm(H) x 500 mm(W) x 378 mm(D) (6-9/16" x 19-3/4" x 14-15/16")
Weight	: 12.4 kg (27.3 lbs.)
Amplifier Section	
Output power	: 60 watts per channel, min. RMS, both channels driven, into 8 ohms from 20 Hz to 20 kHz, with no more than 0.03 % total harmonic distortion 65 watts per channel into 8 ohms (1 kHz, THD 0.03 %) 80 watts per channel into 4 ohms (1 kHz, THD 0.03 %)
THD at half rated power, 1 kHz, 8 Ω	: 0.008 %
Intermodulation Distortion	: 0.01 % at rated output
Damping Factor	: 70 at 8 ohms/1 kHz
Load Impedance	: 4 – 16 ohms
Input Sensitivity (Impedance)	: PHONO: 2.5 mV (47k ohms) AUX: 190 mV (50k ohms) TAPE PLAY (pin/DIN): 190 mV (50k ohms)
Signal-to-Noise Ratio (IHF Short-Circuit A Network)	: PHONO: 75 dB AUX: 95 dB TAPE: 95 dB
Recording Output	: Pin: 190 mV DIN: 30 mV (80k ohms)
Frequency Response	: 5 Hz – 40 kHz +0.0 dB, -1.0 dB
Phono Equalizer Deviation	: ± 0.2 dB from 20 Hz to 20 kHz
Phono Overload	: 190 mV (RMS) (THD 0.03 %)
S.E.A. Center Frequencies	: 40, 250, 1 k, 5 k, 15 kHz
S.E.A. Control Range	: ± 12 dB
FM Tuner Section	
Usable Sensitivity*	: 10.8 dBf (1.0 μ V/75 Ω , 1.9 μ V/300 Ω)
50 dB Quieting Sensitivity	: MONO: 14.8 dBf (3.0 μ V/300 Ω) STEREO: 37.3 dBf (39.7 μ V/300 Ω)
Stereo Separation (at REC OUT)	: 50 dB (1 kHz) 40 dB (50 Hz – 10 kHz)
Distortion	: 100 Hz: 0.1 % (Mono) 0.1 % (Stereo) 1 kHz: 0.08 % (Mono) 0.1 % (Stereo) 6 kHz: 0.15 % (Mono) 0.4 % (Stereo)
Signal-to-Noise Ratio (IHF weighted)	: MONO: 78 dB STEREO: 70 dB
Alternate Channel Selectivity	: 80 dB
Capture Ratio	: 1.0 dB
Image Response Ratio	: 55 dB at 98 MHz
IF Response Ratio	: 80 dB at 98 MHz
AM Suppression	: 65 dB
Frequency Response	: 20 Hz – 15 kHz +0.3 dB, -0.8 dB
AM Tuner Section	
Sensitivity	: 290 μ V/m (Bar Antenna) 30 μ V (Ex. Antenna)
Selectivity ± 10 kHz	: 50 dB
Signal-to-Noise Ratio	: 55 dB

* Figures in () are based upon '58 IHF standard.

Specifications subject to change without notice.

2. Level Diagram

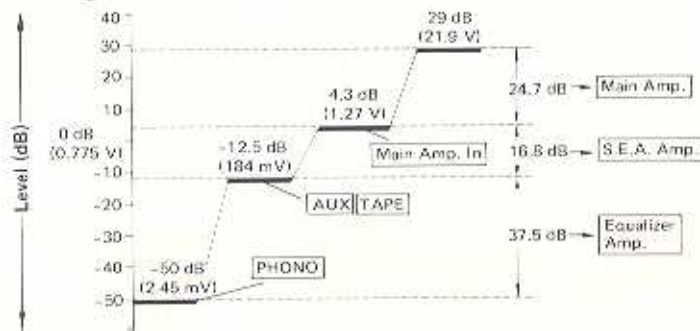

Fig. 1

3. Removal Procedures

3-(1) Top Cover and Bottom Plate

Procedure

1. Remove 4 screws (Item No. 5) and also 4 screws (Item No. 6) through the both sides of the cover and 3 screws (Item No. 7) from the back of the top cover. See Fig. 2.
2. Remove the top cover.

Note: When removing the top plate (Item No. 1) only, remove 7 screws (Item No. 4, No. 7).

3. Remove 4 screws (Item No. 10) from the bottom plate (Item No. 11) and remove it from the chassis.

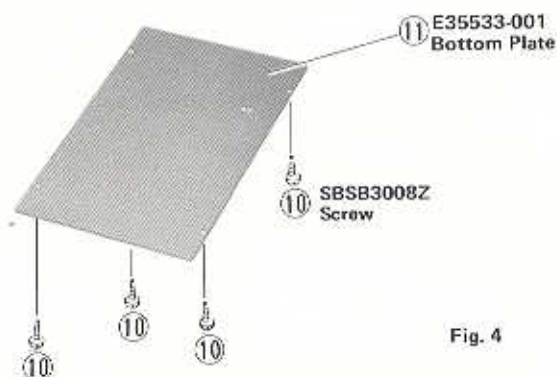
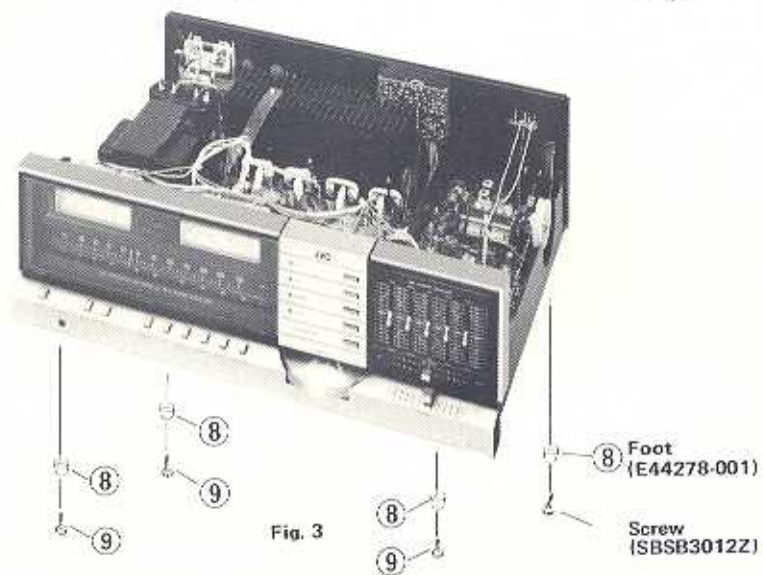
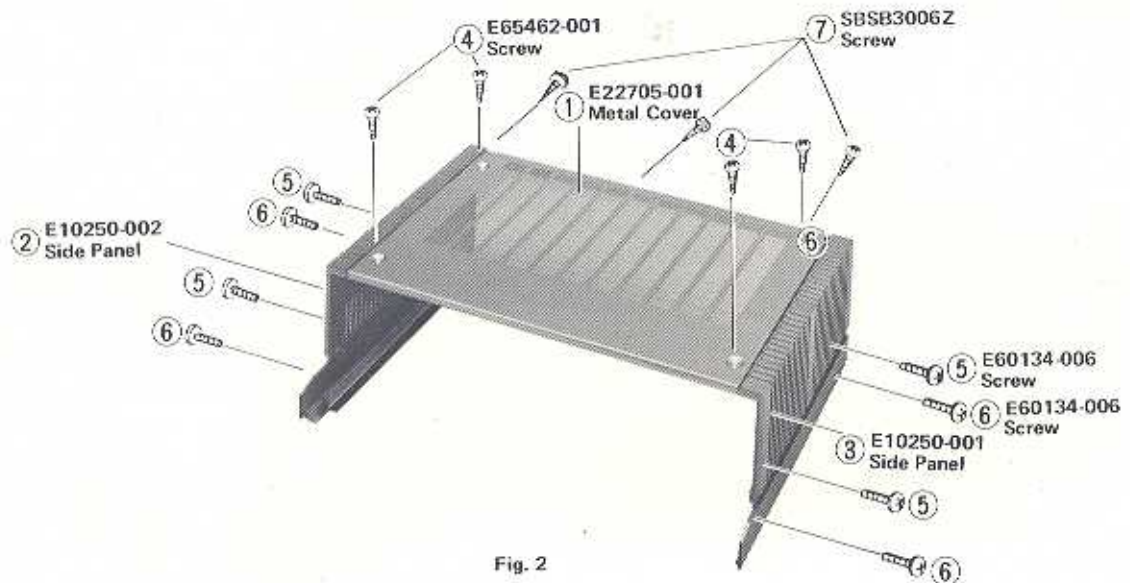

3-(2) Front Panel and Window Screen

Procedure (Front Panel)

1. Remove 4 screws (Item No. 12) from the both sides of chassis and remove 3 screws (Item No. 14) from the bottom. See Fig. 6.
2. Remove 2 screws (Item No. 13) from the "L" typed brackets (Item No. 15, 16).

Procedure (Window Screen)

1. Remove 3 screws (Item No. 17) and a holder (Item No. 18).
2. Remove a window screen (Item No. 19).

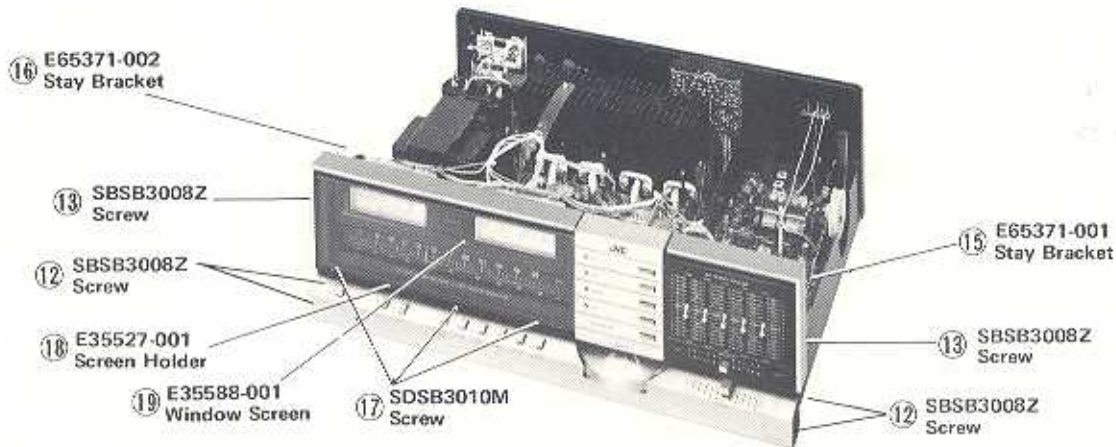

Fig. 5

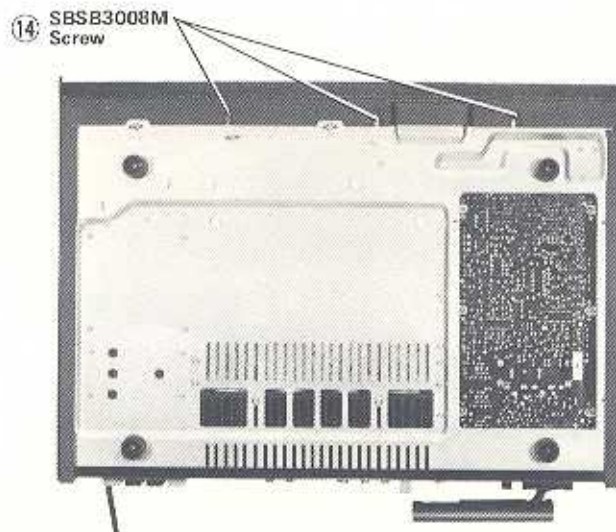

Fig. 6

3-(3) Pushbuttons

Procedure (Functions)

1. Remove "E" typed ring (Item No. 36) and a shaft (Item No. 35) from the button holder (Item No. 34) carefully.
2. Pushbuttons will be removed. Refer to Fig. 7A.

Procedure (Source)

1. Remove a nut (Item No. 41) and a source panel (Item No. 42) from the front panel.
2. Remove the escutcheons (Item No. 37).
3. Squeeze the both ends of escutcheon then, pull out the pushbuttons (Item No. 38) slightly. Refer to Fig. 7B.

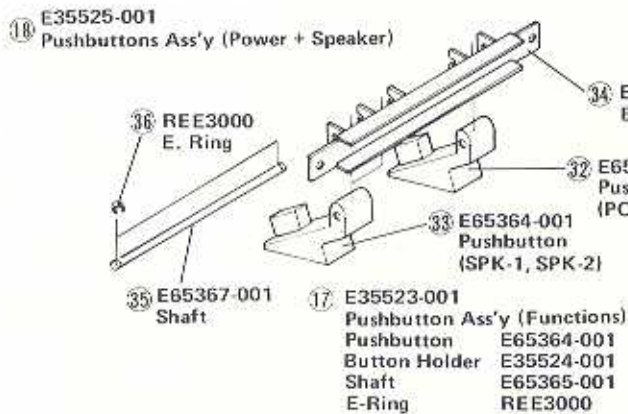

Fig. 7A

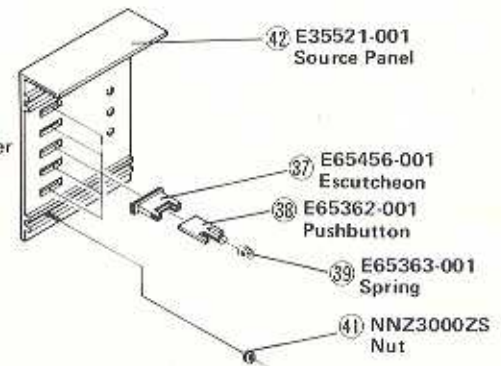

Fig. 7B

3-(4) TXX-112-1 P. C. Board Ass'y

Procedure

1. Remove 2 screws (Item No. 43) from the bottom chassis.
2. Remove 4 screws (Item No. 44) from both sides of a heat sink bracket.
3. Remove 2 fasteners (Item No. 45) located on TXX-112 P.C. Board Ass'y.
4. Remove TXX-112 with the heat sink and place it carefully as shown in Fig. 8.

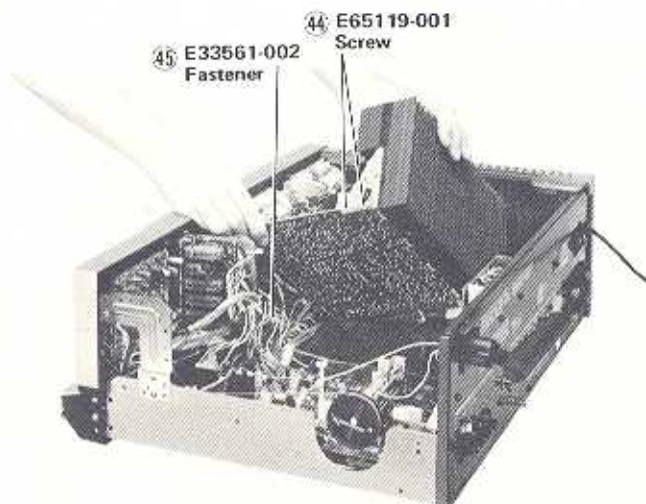

Fig. 8

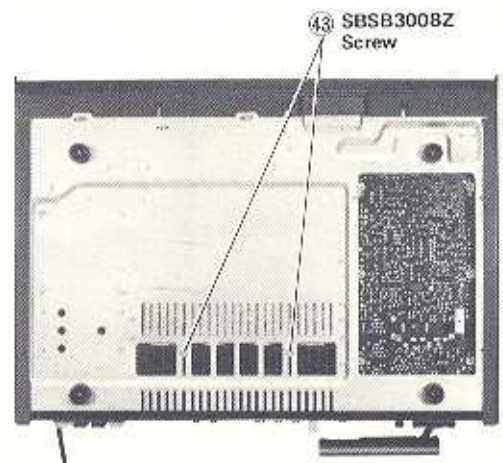

Fig. 9

4. Main Parts Location and Part Numbers

Top View

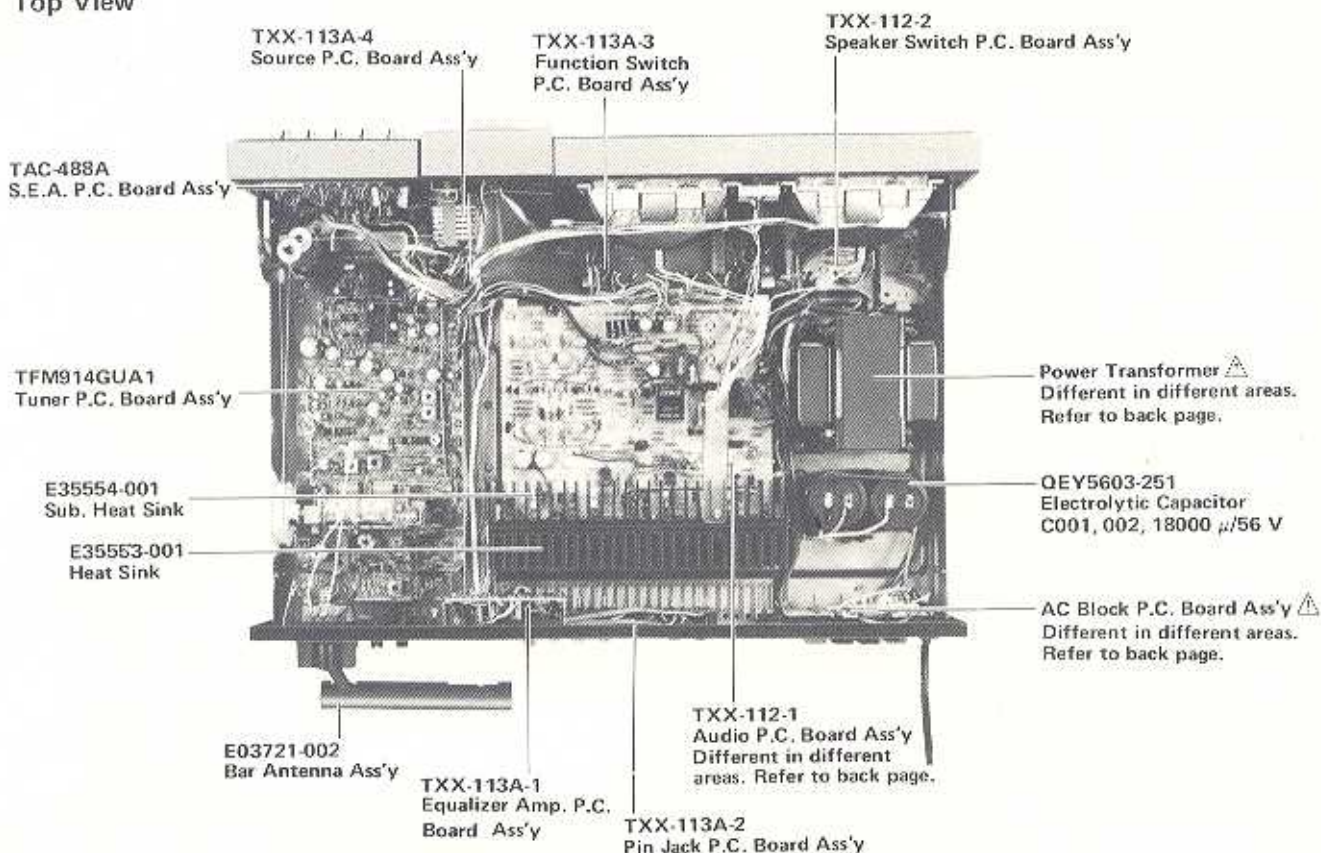

Fig. 10

Bottom View

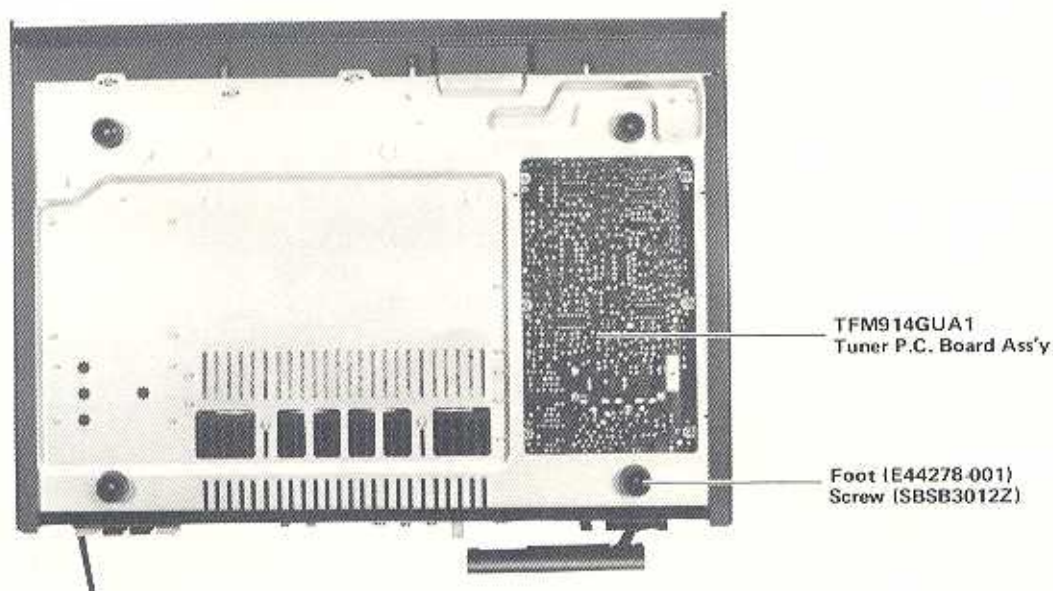

Fig. 11

5. Exploded Views and Part Numbers

5-(1) Front Panel

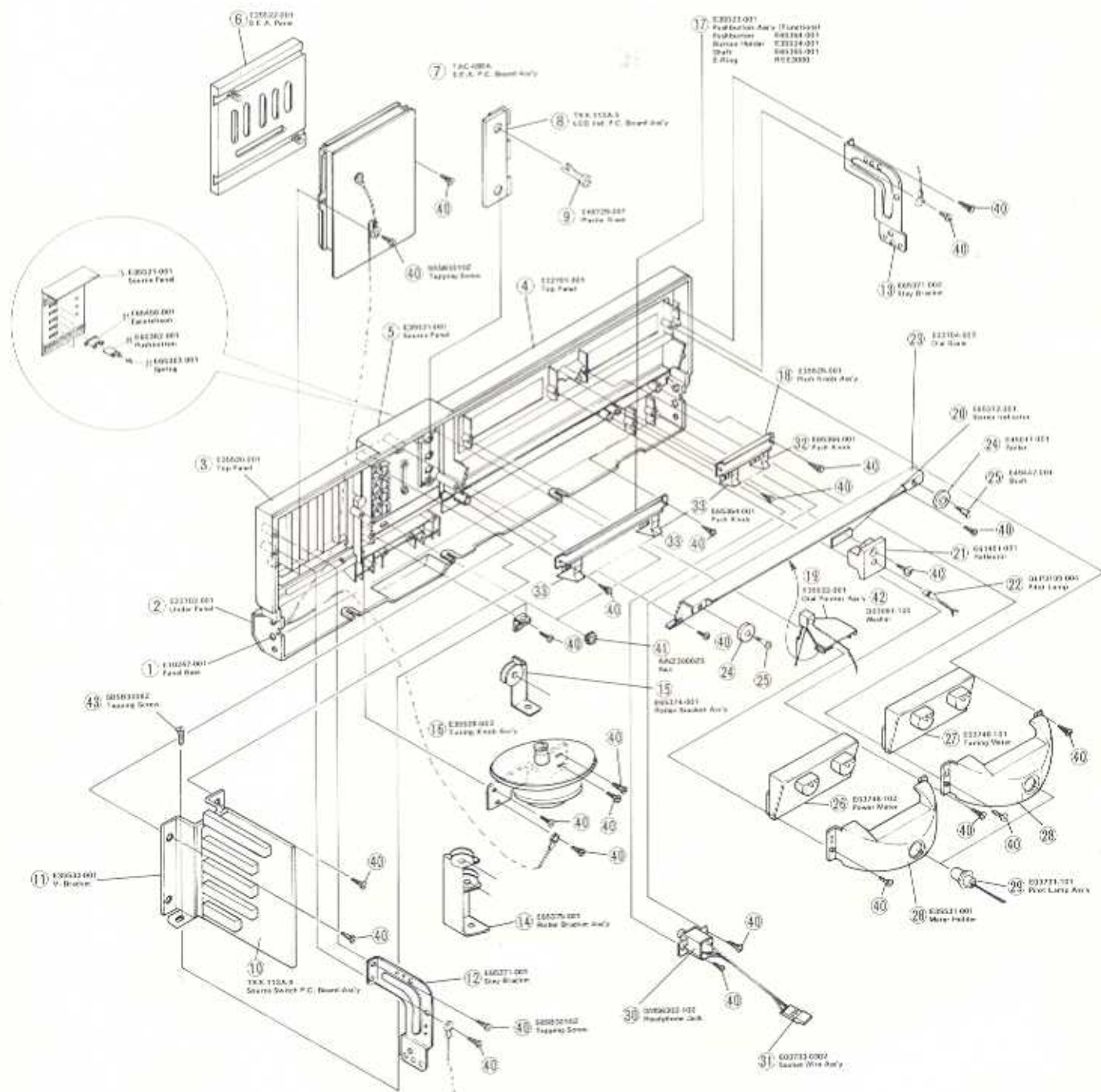

Fig. 12

5-(2) Rear Panel

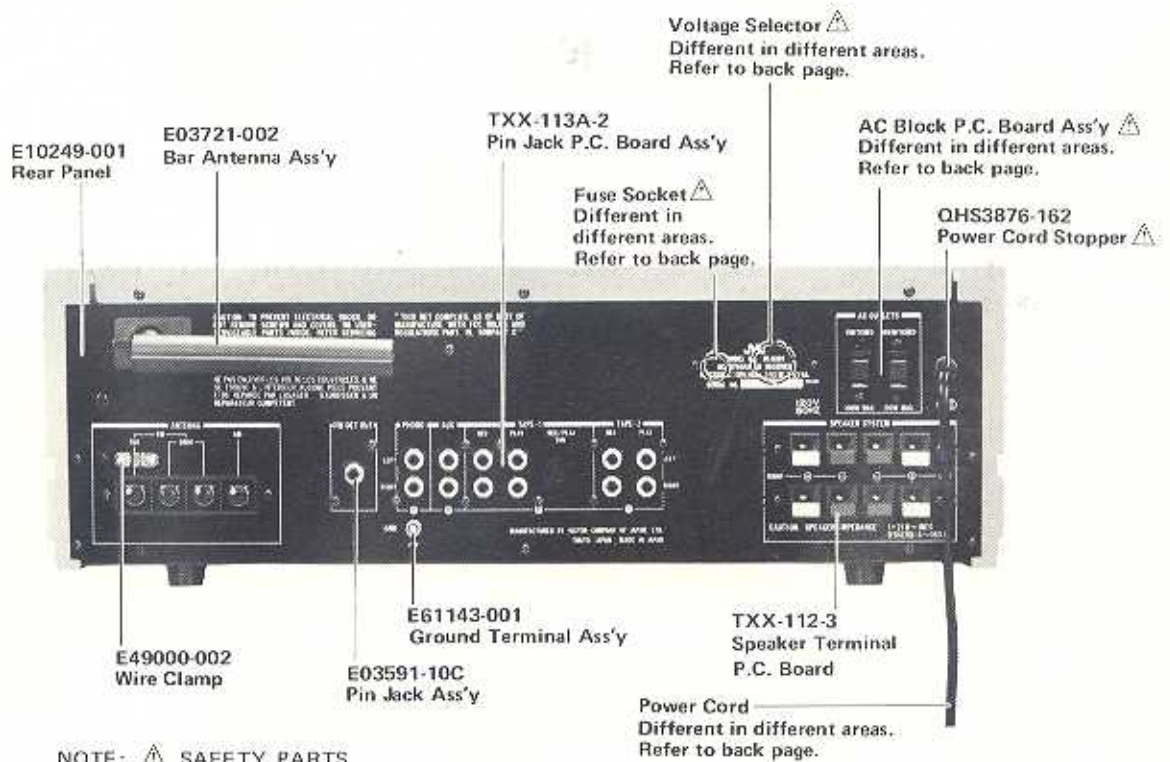

Fig. 13

6. Dial Stringing Procedures

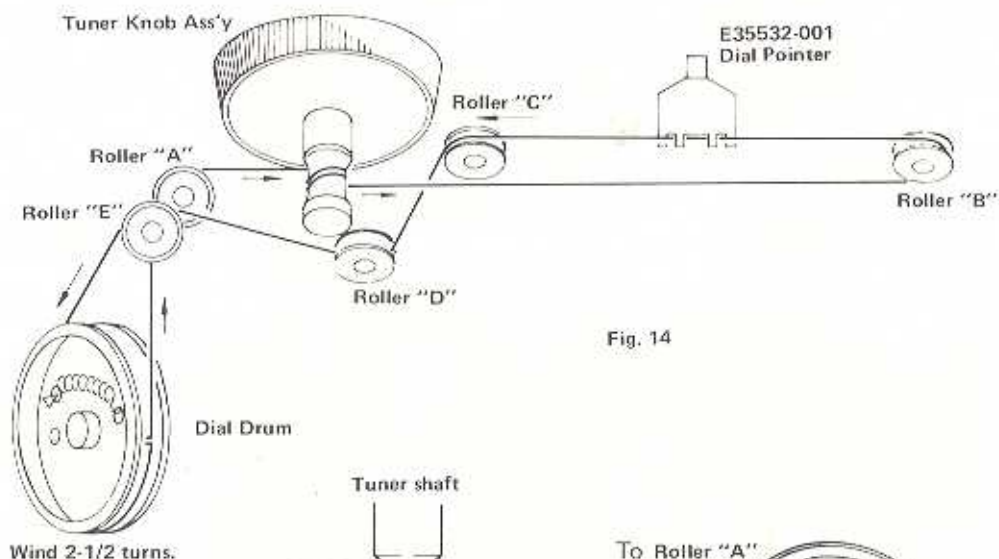

Fig. 14

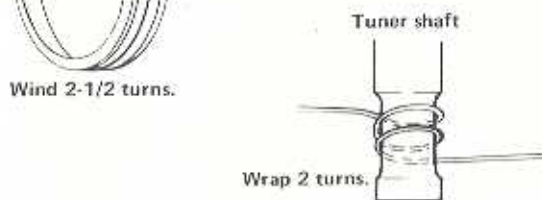

Fig. 15

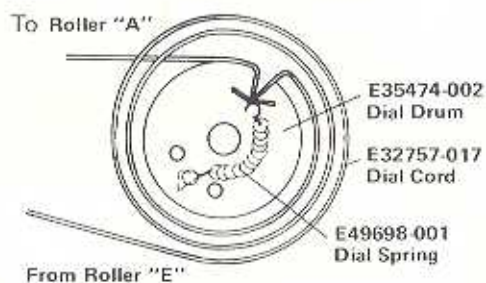

Fig. 16

Procedure

1. Remove the dial pointer and the old cord.
2. Tie end of new dial cord to one end of dial spring. Connect other end of dial spring of bottom right eye inside dial drum. See Fig. 16.
3. Rotate tuning capacitor dial drum to its maximum clockwise.
4. Run the dial cord through the slot in the rim of the dial drum.
5. Guide the dial cord under and around roller "A".
6. Pull the dial cord taut and wrap 2 turns clockwise. See Fig. 15.
7. Guide the dial cord under and around roller "B", "C" and "D". Keep the dial cord taut during this procedure.
8. Guide the dial cord over the dial drum and wind 2-1/2 turns clockwise. See Fig. 16.
9. Guide the dial cord over and around roller "E".
10. Turn the tuning shaft to rotate the dial drum fully counterclockwise and fully clockwise to distribute the tensioning along the dial cord.
11. Place the dial cord over and under the tabs on the rear of the dial pointer and place the dial pointer on the top of the dial panel rail. See Fig. 14.
12. Turn the tuning shaft clockwise. Slide the dial pointer to ZERO (0) calibration marker on the logging scale while holding tuning shaft fully clockwise. Cement the dial pointer to dial cord to prevent slippage. Allow cement to dry thoroughly.
13. Replace the top (Metal) cover.

7. FM/AM Tuner Alignment Procedures

TFM914GUA1 FM/AM Tuner P.C. Board Ass'y

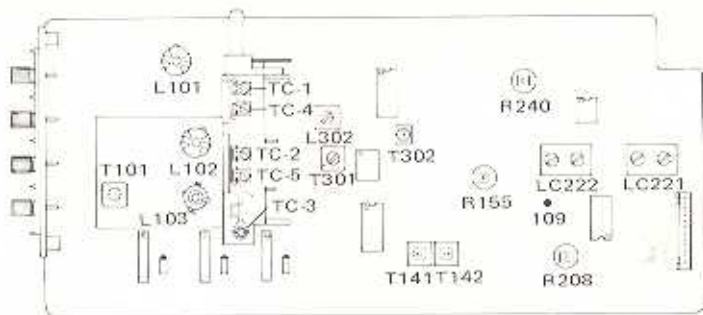

Fig. 17

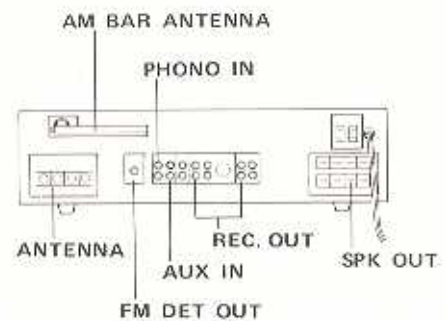

Fig. 18

7-(1) FM Section

Discriminator, FM Tuning Meter and Distortion

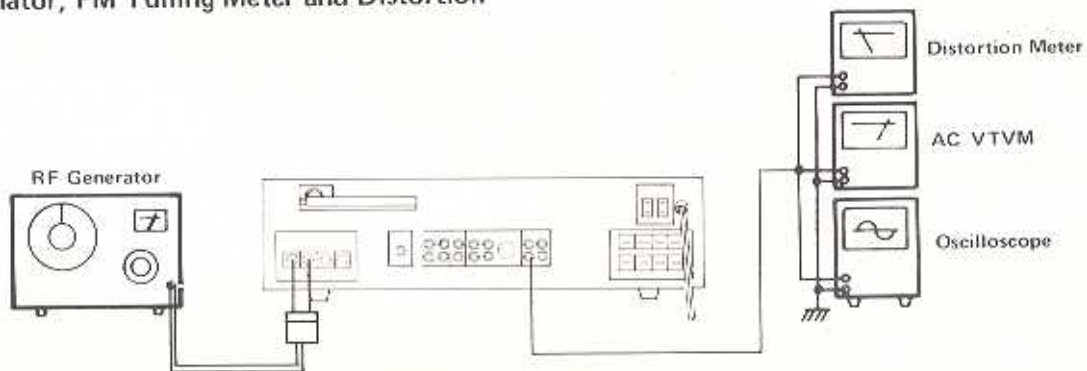

Fig. 19

1. Connect an RF generator, 400 Hz modulation and 75 kHz deviation, to the antenna terminals on the rear panel through a dummy antenna.
2. Connect an oscilloscope, distortion meter and VTVM to the Rec. Out Jacks on the rear panel.
3. Tune to a frequency where there is no broadcasting.
4. Adjust the core of T141 so that the FM Tuning Meter deflects to the center position.
5. Set the generator to 98 MHz.
6. Tune to 98 MHz signal.
7. Adjust the core of T142 so that the distortion is minimized.

Tracking and Sensitivity

Precaution: No adjustment is required. The tracking and sensitivity has been adjusted properly and completely at the factory. If any special reason occasioned, take the following procedures very carefully:

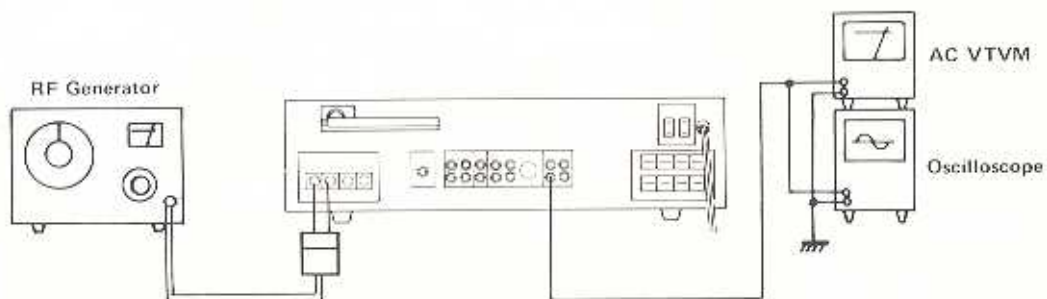

Fig. 20

Low Frequency

1. Connect an RF generator to the antenna terminals on the rear panel through a dummy antenna.
2. Set the RF generator to 88 MHz, a modulation of 400 Hz and a deviation of 75 kHz, to provide an input of $2 \mu V$.
3. Connect a VTVM and an oscilloscope to the Rec. Out Jacks on the rear panel.
4. Set the dial pointer to 88 MHz.
5. Adjust three coils L103, L102 and L101 in the tuning gang to maximize the output.

High Frequency

6. Set the RF generator 108 MHz, a modulation of 400 Hz and a deviation of 75 MHz, to provide an input of $2 \mu\text{V}$.
7. Set the dial pointer to 108 MHz.
8. Adjust the FM trimmers TC3, TC2 and TC1 in the tuning gang to maximize the output.
9. Repeat these high and low frequency adjustments alternately until maximum sensitivity is obtained.

Muting Level (Check Up) (See Fig. 20)

Note: No adjustment is necessary. However, if the check up is required, take the following steps.

1. Connect a VTVM and an oscilloscope to the Rec. Out Jacks.
2. Set the RF generator to 108 MHz, a modulation of 1 kHz and a deviation of 75 kHz, to provide an input of $10 \mu\text{V}$. Keep the front muting switch on.
3. Turn R155 clockwise and remember the point at which the muting ceases operating.
4. Turn R155 counterclockwise slightly so that the output level drops by 1 dB.
5. Attenuate the output of the RF generator to 2 dB from $10 \mu\text{V}$ of Step 2 and check that the muting is still operating.

P.L.L. Free Running Frequency and Stereo Separation

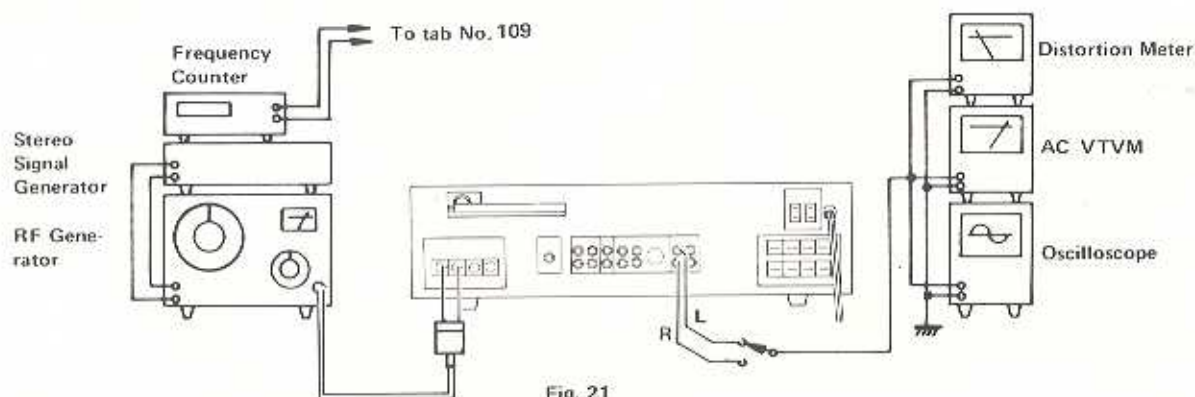

Fig. 21

P.L.L. Free Running Frequency

1. Connect the RF generator to the antenna terminals through a dummy antenna.
2. Connect a VTVM, an oscilloscope and a distortion meter to the Rec. Out Jacks.
3. Set the RF generator to 98 MHz and an output of 1 mV at 400Hz modulation and 75kHz deviation.
4. Set the dial pointer to 98 MHz.
5. Connect a frequency counter to Tab. No. 109.
6. Adjust R208 so that the frequency counter indicates 19 kHz (± 0.01 kHz).

Stereo Separation

1. Set a stereo signal generator as follows: Modulation frequency 400 Hz, Deviation pilot 7.5 kHz, Main and Sub. carrier 67.5 kHz. Connect its output to an RF generator. Set the RF generator to 98 MHz and output of 1 mV.
2. Switch the selector of the stereo modulator to left channel modulation.
3. Adjust R240 so that the output of the right channel is minimized.
4. Switch the selector of the modulator to right channel modulation.
5. Adjust R240 so that the output of the left channel is minimized.
6. Set R240 to average, if the separation of right and left are different.

Note: Keep the mono pushbutton out during this adjustment procedure of stereo separation.

7-(2) AM Section

Tracking and Sensitivity

Low Frequency

1. Connect an RF generator to the antenna terminals on the rear panel, set this to 600 kHz with 30 % modulation at 400 Hz.
2. Connect an AC VTVM and an oscilloscope to Rec. Out Jacks on the rear panel.
3. Set the dial pointer to 600 kHz.
4. Adjust Osc. transformer L302 and the ferrite bar antenna core to maximize the output signal.

High Frequency

5. Set the RF generator to 1 400 kHz with 30 % modulation at 400 Hz.
6. Set the dial pointer to 1 400 kHz.
7. Adjust the trimmers TC4 and TC5 in the AM tuning gang so that the output signal is maximized.
8. Repeat these high and low frequency adjustments alternately until maximum sensitivity is obtained.

8. Power Amplifier Adjustment Procedures

8-(1) Center Voltage

() : For Right Channel Adjustment

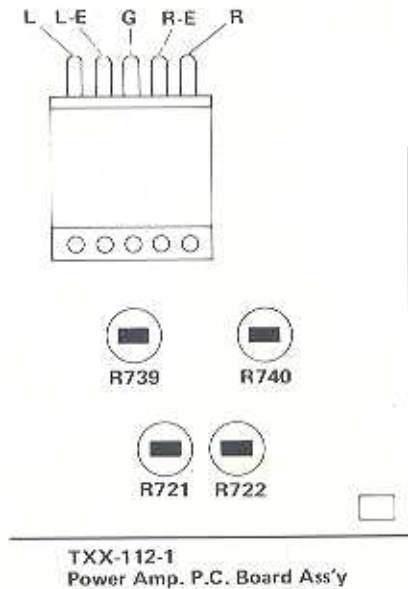

Fig. 22A

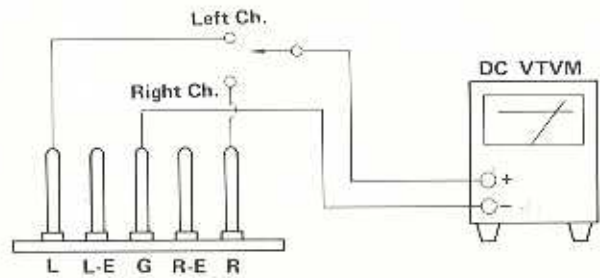

Fig. 22B

Procedure

Precaution: Allow the set to warm up at least 5 minutes before connecting a DC VTVM.

1. Set R721 (R722) located on TXX-112-1 to center position before pressing the power switch on. Refer to Fig. 22A.
2. Connect a DC VTVM to test points "L" and "G" ("R" and "G"). Refer to Fig. 22B.
3. Adjust R721 (R722) for DC VTVM reading of 0 mV. Refer to Fig. 22A.

8-(2) Idling Current

() : For Right Channel Adjustment

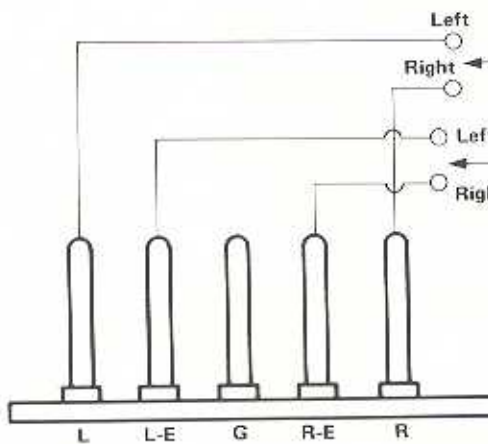

Fig. 23A

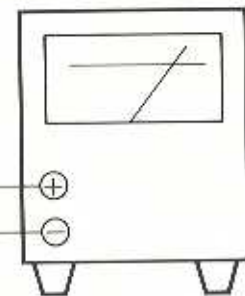

Fig. 23B

Procedure

Precaution: Allow the set to warm up at least 5 minutes before connecting a DC VTVM.

1. Turn R739 and R740 fully counterclockwise before pressing the power switch on. Refer to Fig. 23A.
2. Connect a DC VTVM to test points "L" and "L-E" ("R" and "R-E"). Refer to Fig. 23B.
3. Adjust R739 (R740) for a DC VTVM reading of -10 mV.

Note: The heat sinks must be cooled and the volume control set to minimum during these adjustment procedures.

9. Printed Circuit Board Ass'y and Parts List

9-(1) TXX-112 Audio P. C. Board Ass'y

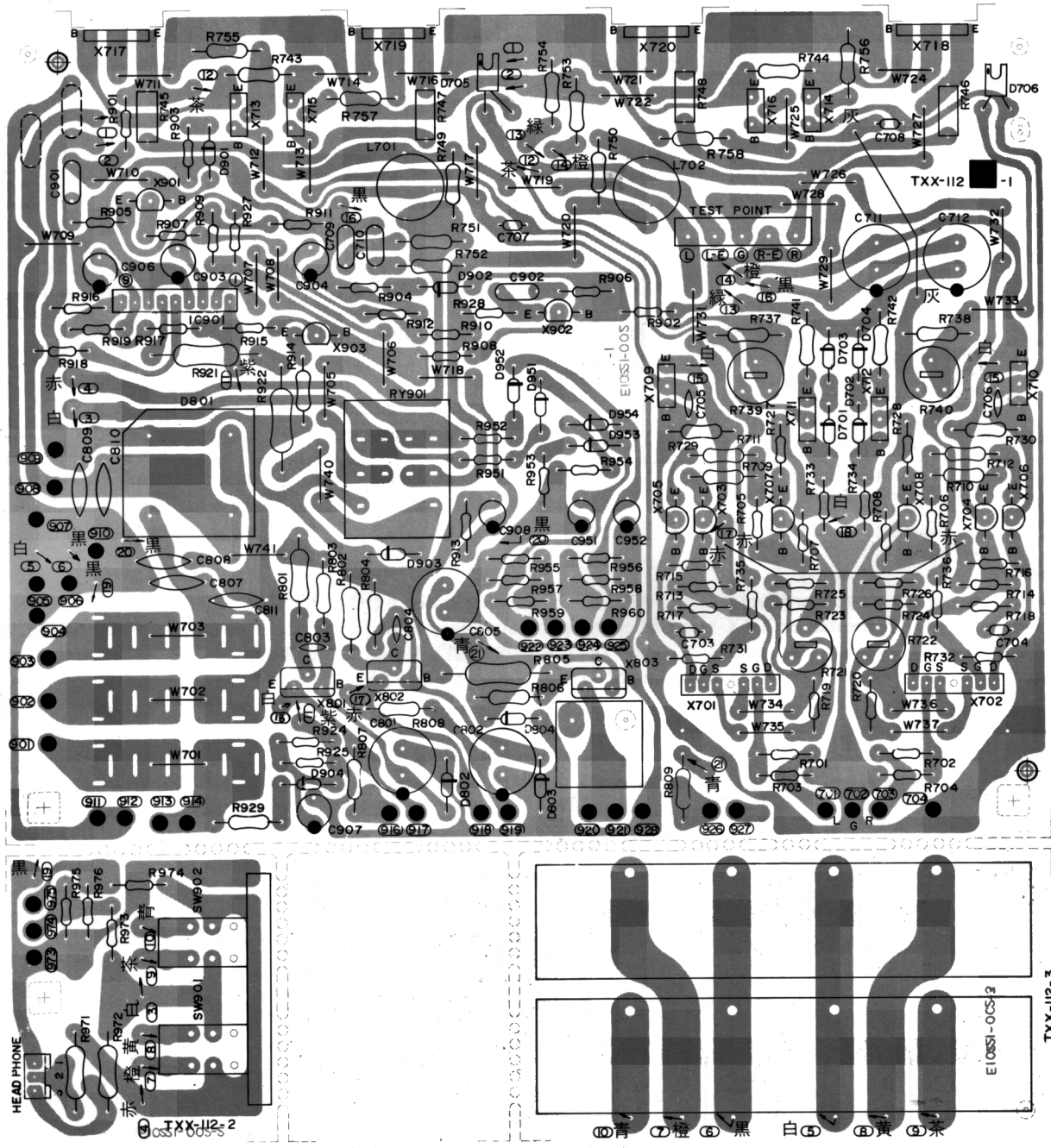

Locations

1. TXX-112-1 Power Amp. P.C. Board Ass'y
2. TXX-112-2 Speaker Switch P.C. Board Ass'y
3. TXX-112-3 Speaker Terminals P.C. Board Ass'y

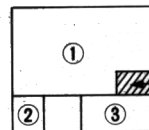

CAUTION

If this section (shaded) of the printed wiring is different from the above, see CAUTION TABLE at page 17.

Fig. 24

Note: The number of TXX-112 varies according to the area employed. See table below.

P.C. Board Ass'y	Areas	Fuse clip	Fuse label
TXX-112A	for U.S.A., Military Market and Other Countries	E45524-001	E65489-001
TXX-112B	for Canada only	E45524-001	E65407-001
TXX-112C	for Europe, Australia and U.K.	E48965-002	E65407-002
			E65407-002BS (U.K. only)

Transistors

Item No.	Part Number	Rating		Description	Maker
		Pc	fT		
X701	MPA63H(1)	0.2 W		F.E.T.	NEC
X702	MPA63H(1)	"		"	"
X703	2SC1775AV(F)	0.3 W	200 MHz	Silicon	Hitachi
X704	2SC1775AV(F)	"	"	"	"
X705	2SC1775AV(F)	"	"	"	"
X706	2SC1775AV(F)	"	"	"	"
X707	2SC1775AV(F)	"	"	"	"
X708	2SC1775AV(F)	"	"	"	"
X709	2SA899(B, V)	1 W	100 MHz	"	Fujitsu
X710	2SA899(B, V)	"	"	"	"
X711	2SC1904(B, V)	"	"	"	"
X712	2SC1904(B, V)	"	"	"	"
X713	2SD669A(B, C)	20 W	140 MHz	"	Hitachi
X714	2SD669A(B, C)	"	"	"	"
X715	2SB649A(B, C)	"	"	"	"
X716	2SB649A(B, C)	"	"	"	"
X717	2SD738(B, C)	125 W	10 MHz	"	"
X718	2SD738(B, C)	"	"	"	"
X719	2SB702(B, C)	"	18 MHz	"	"
X720	2SB702(B, C)	"	"	"	"
X801	2SB514V(D, E)	20 W	8 MHz	"	Sanyo
X802	2SD330V(D, E)	"	"	"	"
X803	2SD330V(D, E)	"	"	"	"
X901	2SC1775AV(F)	0.3 W	200 MHz	"	Hitachi
X902	2SC1775AV(F)	"	"	"	"
X903	2SA872AV(E)	"	120 MHz	"	"

Integrated Circuit

Item No.	Part Number	Rating (Pc)		Description	Maker
IC901	TA7317P	0.5 W		I.C.	Toshiba

Diodes

Item No.	Part Number	Rating		Description	Maker
D701	1S2473			Silicon	Toyo Dengu
D702	1S2473			"	"
D703	1S2473			"	"
D704	1S2473			"	"
D705	STV3H			Varistor	Sanken
D706	STV3H			"	"
D801	S5VB20			Silicon	Shindengen
D802	WZ-280			"	JRC
D803	WZ-280			"	"
D804	XZ-132			"	"
D901	1S2473			"	Toyo Dengu
D902	1S2473			"	"
D903	1S2473			"	"
D904	1S2473			"	"
D951	1S2473			"	"
D952	1S2473			"	"
D953	1S2473			"	"
D954	1S2473			"	"

Coils & Transformers

Item No.	Part Number	Rating		Description
L701	E04059-1R2	1.2 μF		Choke Coil
L702	E04059-1R2	"		"

Capacitors

Item No.	Part Number	Rating		Description
C703	QFM31HK-102	1000 pF	50 V	Mylar
C704	QFM31HK-102	"	"	"
C705	QCS31HJ-270	27 pF	"	Ceramic
C706	QCS31HJ-270	"	"	"
C707	QFM31HK-103	0.01 μF	"	Mylar
C708	QFM31HK-103	"	"	"
C709	QFM31HK-473	0.047 μF	"	"
C710	QFM31HK-473	"	"	"
C711	QEW51JA-107	100 μF	63 V	Electrolytic
C712	QEW51JA-107	"	"	"
C801	QEW51VA-107	"	35 V	"
C802	QEW51VA-107	"	"	"
C803	QCF31HP-103	0.01 μF	50 V	Ceramic
C804	QCF31HP-103	"	"	"
C805	QEW51VA-227	220 μF	35 V	Electrolytic
C807	QCF12HP-103	0.01 μF	500 V	Ceramic
C808	QCF12HP-103	"	"	"
C809	QCF12HP-103	"	"	"
C810	QCF12HP-103	"	"	"
C901	QFM31HK-104	0.1 μF	50 V	Mylar
C902	QFM31HK-104	"	"	"
C903	QEW51AA-107	100 μF	10 V	Electrolytic
C904	QEW51AA-107	"	"	"
C906	QEW51AA-226	22 μF	"	"
C907	QEW51HA-105	1 μF	50 V	"
C908	QEW51HA-106	10 μF	"	"
C951	QEW51AA-106	"	"	"
C952	QEW51AA-106	"	"	"

Resistors

Item No.	Part Number	Rating		Description
R701	QRD141J-122S	1.2 k Ω	1/4 W	Carbon
R702	QRD141J-122S	"	"	"
R703	QRD141J-563S	56 k Ω	"	"
R704	QRD141J-563S	"	"	"
R705	QRD141J-183S	18 k Ω	"	"
R706	QRD141J-183S	"	"	"
R707	QRD141J-822S	8.2 k Ω	"	"
R708	QRD141J-822S	"	"	"
R709	QRG129J-121	120 Ω	1/2 W	Oxide Metal Film
R710	QRG129J-121	"	"	"
R711	QRG129J-121	"	"	"
R712	QRG129J-121	"	"	"
R713	QRD141J-123S	12 k Ω	1/4 W	Carbon
R714	QRD141J-123S	"	"	"
R715	QRD141J-123S	"	"	"
R716	QRD141J-123S	"	"	"
R717	QRD141J-122S	1.2 k Ω	"	"
R718	QRD141J-122S	"	"	"
R719	QRD141J-560S	56 Ω	"	"

Resistors

Item No.	Part Number	Rating		Description
R720	QRD141J-560S	56 Ω	1/4 W	Carbon
R721	QVP4A0B-221	220 Ω		Variable
R722	QVP4A0B-221	"		"
R723	QRD141J-222S	2.2 k Ω	1/4 W	Carbon
R724	QRD141J-222S	"	"	"
R725	QRD141J-222S	"	"	"
R726	QRD141J-222S	"	"	"
R727	QRD141J-472S	4.7 k Ω	"	"
R728	QRD141J-472S	"	"	"
R729	QRG129J-102	1 k Ω	1/2 W	Oxide Metal Film
R730	QRG129J-102	"	"	"
R731	QRD141J-332S	3.3 k Ω	1/4 W	Carbon
R732	QRD141J-332S	"	"	"
R733	QRD141J-473S	47 k Ω	"	"
R734	QRD141J-473S	"	"	"
R735	QRD141J-563S	56 k Ω	"	"
R736	QRD141J-563S	"	"	"
R737	QRG129J-391	390 Ω	1/2 W	Oxide Metal Film
R738	QRG129J-391	"	"	"
R739	QVP4A0B-221	220 Ω		Variable
R740	QVP4A0B-221	"		"
R741	QRG129J-101	100 Ω	1/2 W	Oxide Metal Film
R742	QRG129J-101	"	"	"
R743	QRG129J-271	270 Ω	"	"
R744	QRG129J-271	"	"	"
R745	ORM054K-R47	0.47 Ω	5 W	Metal Plate
R746	ORM054K-R47	"	"	"
R747	ORM054K-R47	"	"	"
R748	ORM054K-R47	0.47 Ω	5 W	Metal Plate
R749	QRX129J-4R7	4.7 Ω	1/2 W	Oxide Metal Film
R750	QRX129J-4R7	"	"	"
R751	QRX129J-100	10 Ω	"	"
R752	QRX129J-100	"	"	"
R753	QRG129J-470	47 Ω	"	"
R754	QRG129J-470	"	"	"
R755	QRD126J-100	10 Ω	"	Carbon
R756	QRD126J-100	"	"	"
R757	QRD126J-100	"	"	"
R758	QRD126J-100	"	"	"
R801	QRG017J-151S	150 Ω	1 W	Oxide Metal Film
R802	QRG017J-151S	"	"	"
R803	QRG129J-472	4.7 k Ω	1/2 W	"
R804	QRG129J-472	"	"	"
R805	QRG027J-820	82 Ω	2 W	"
R806	QRG129J-332	3.3 k Ω	1/2 W	"
R807	QRG129J-151	150 Ω	"	"
R808	QRG129J-151	"	"	"
R809	QRG129J-222	2.2 k Ω	"	"
R901	QRD141J-222S	"	1/4 W	Carbon
R902	QRD141J-222S	"	"	"
R903	QRD141J-562S	5.6 k Ω	"	"
R904	QRD141J-562S	"	"	"
R905	QRD141J-101S	100 Ω	"	"
R906	QRD141J-101S	"	"	"
R907	QRD141J-123S	12 k Ω	"	"
R908	QRD141J-123S	"	"	"
R909	QRD141J-104S	100 k Ω	"	"
R910	QRD141J-104S	"	"	"
R911	QRD141J-563S	56 k Ω	"	"
R912	QRD141J-563S	"	"	"
R913	QRD141J-103S	10 k Ω	"	"

Resistors

Item No.	Part Number	Rating		Description
R914	ORG129J-471	470 Ω	1/2 W	Oxide Metal Film
R915	QRD141J-563S	56 kΩ	1/4 W	Carbon
R916	QRD141J-183S	18 kΩ	"	"
R917	QRD141J-683S	68 kΩ	"	"
R918	QRD141J-153S	15 kΩ	"	"
R919	QRD141J-224S	220 kΩ	"	"
R921	ORG027J-331	330 Ω	2 W	Oxide Metal Film
R922	ORG027J-331	"	"	"
R924	QRD141J-563S	56 kΩ	1/4 W	Carbon
R925	QRD141J-223S	22 kΩ	"	"
R927	QRD141J-471S	470 Ω	"	"
R928	QRD141J-471S	"	"	"
R929	ORG129J-102	1 kΩ	1/2 W	Oxide Metal Film
R951	QRD141J-562S	5.6 kΩ	1/4 W	Carbon
R952	QRD141J-562S	"	"	"
R953	QRD141J-221S	220 Ω	"	"
R954	QRD141J-221S	"	"	"
R955	QRD141J-222S	2.2 kΩ	"	"
R956	QRD141J-222S	"	"	"
R957	QRD141J-273S	27 kΩ	"	"
R958	QRD141J-273S	"	"	"
R959	QRD141J-822S	8.2 kΩ	"	"
R960	QRD141J-822S	"	"	"
R971	ORG017J-221S	220 Ω	1 W	Oxide Metal Film
R972	ORG017J-221S	"	"	"
R973	QRD141J-332S	3.3 kΩ	1/4 W	Carbon
R974	QRD141J-332S	"	"	"
R975	QRD141J-681S	680 Ω	"	"

Others

Item No.	Part Number	Rating	Description
	E03728-3-15-1		Parallel Wire
	E03732-003A		3 Pins Plug
	E61537-002		Heat Sink (X803)
	E65376-001		C.B. Holder (Right)
	E65376-002		C.B. Holder (Left)
	E03572-008B		SPK. Terminal
	QSP0220-102		Push-switch
	E03628-5UD		5 Pins Plug
	E35553-001		Heat Sink
	E35554-001		Sub Heat Sink
RY901	ESK6D24-211		Relay Switch

Caution Table

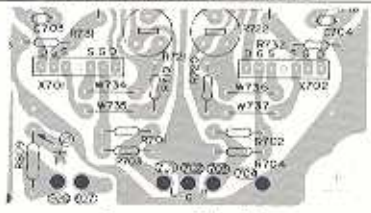
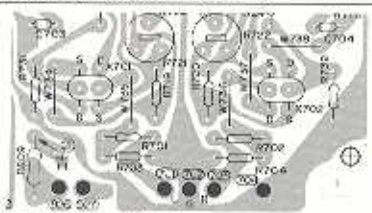
Apply to:		Serial Number over 02066		Serial Number 00065 ~ 02065	
Printed Wiring (part of shadow)		 <p>Same as Fig. 24</p>		 <p>Different Wiring</p>	
	Item No.	Part Number	Rating	Part Number	Rating
Transistors	X701	MPA63H(1)	0.2 W	2SK129	0.25 W
	X702	MPA63H(1)	0.2 W	2SK129	0.25 W

The serial numbers shown in the table are pointed out the last five digits of the serial number located on the rear panel.

For example, 02066 → □□□02066

9-(2) TXX-113A Equalizer Amp., Switches and Indicator P. C. Board Ass'y

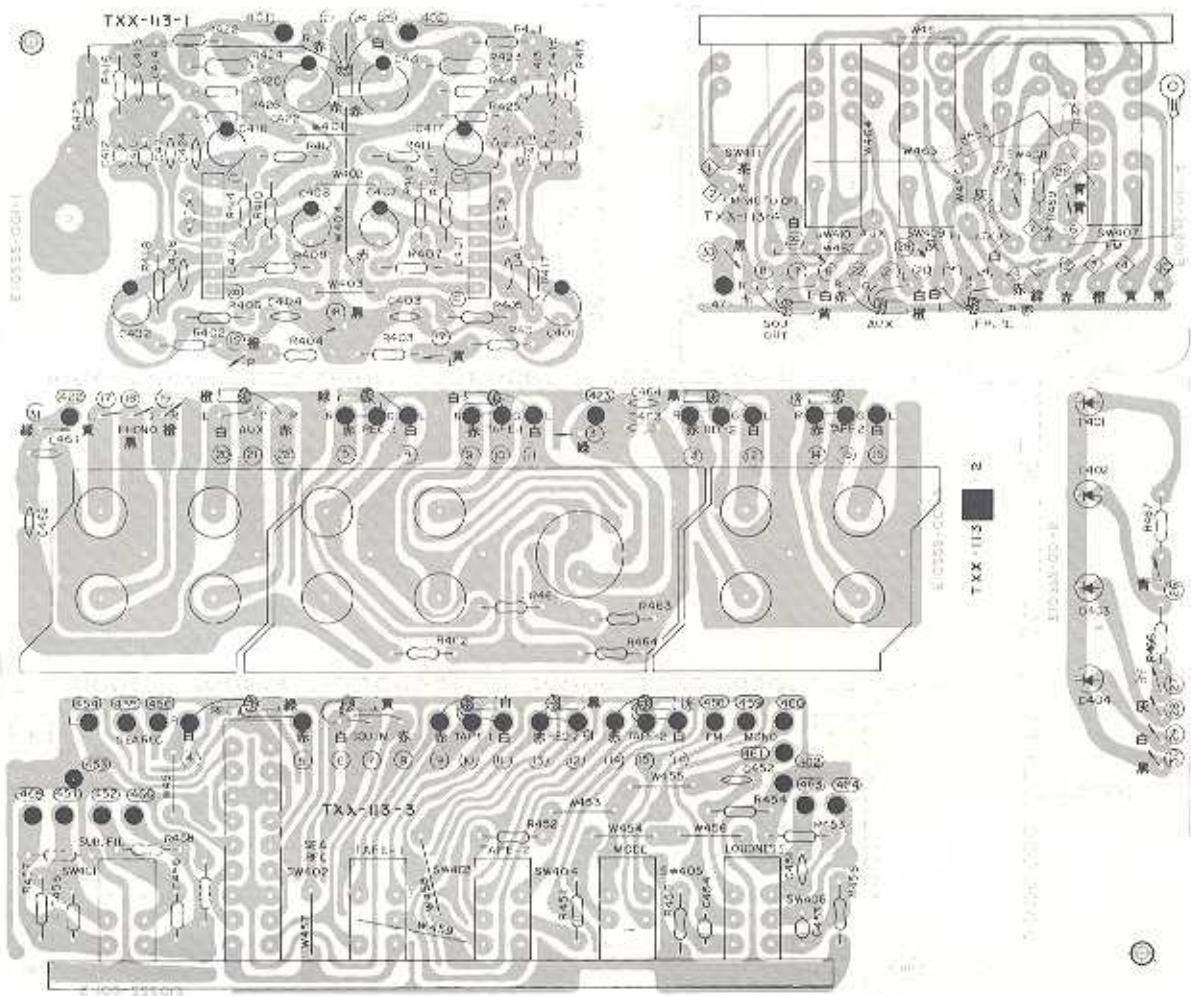

Fig. 25

Locations

- | | |
|--|---|
| <ol style="list-style-type: none"> 1. TXX-113A-1
Equalizer Amp. P.C. Board Ass'y 2. TXX-113A-2
Pin Jack P.C. Board Ass'y | <ol style="list-style-type: none"> 3. TXX-113A-3
Function Switches P.C. Board Ass'y 4. TXX-113A-4
Source Switches P.C. Board Ass'y 5. TXX-113A-5
LED Indicators P.C. Board Ass'y |
|--|---|



Integrated Circuits

Item No.	Part Number	Rating (Pc)	Description	Maker
IC401	HA1457	0.5 W	I.C.	Hitachi
IC402	HA1457	"	"	"

Diodes

Item No.	Part Number	Rating	Description	Maker
D401	TLR102		L.E.D.	Toshiba
D402	TLR102		"	"
D403	TLR102		"	"
D404	TLR102		"	"

Capacitors

Item No.	Part Number	Rating		Description
C401	QEB51EM-475	4.7 μ F	25 V	Low Leak Current Electrolytic
C402	QEB51EM-475	"	"	"
C403	QCS31HJ-470	47 pF	50 V	Ceramic
C404	QCS31HJ-470	"	"	"
C405	QCS31HJ-101	100 pF	"	"
C406	QCS31HJ-101	"	"	"
C407	QEW51AA-107	100 μ F	10 V	Electrolytic
C408	QEW51AA-107	"	"	"
C409	QFP32AG-332	3300 pF	100 V	Polypropylene
C410	QFP32AG-332	"	"	"
C411	QFP32AG-122	1200 pF	"	"
C412	QFP32AG-122	"	"	"
C413	QFP32AG-152	1500 pF	"	"
C414	QFP32AG-152	"	"	"
C415	QCS31HJ-560	56 pF	50 V	Ceramic
C416	QCS31HJ-560	"	"	"
C417	QEB51EM-225	2.2 μ F	25 V	Low Leak Current Electrolytic
C418	QEB51EM-225	"	"	"
C419	QCS31HJ-560	56 pF	50 V	Ceramic
C420	QCS31HJ-560	"	"	"
C421	QEW51EA-226	22 μ F	25 V	Electrolytic
C422	QEW51EA-226	"	"	"
C423	QCS31HJ-271	270 pF	50 V	Ceramic
C424	QCS31HJ-271	"	"	"
C425	QCF31HP-223	0.022 μ F	"	"
C451	QCS31HJ-271	270 pF	"	"
C452	QCS31HJ-271	"	"	"
C453	QFM31HJ-273	0.027 μ F	"	Mylar
C454	QFM31HJ-273	"	"	"
C455	QFM31HJ-154	0.15 μ F	"	"
C456	QFM31HJ-154	"	"	"
C461	QCF31HP-103	0.01 μ F	"	Ceramic
C462	QCF31HP-103	"	"	"
C463	QCF31HP-103	"	"	"
C464	QCF31HP-103	"	"	"

Resistors

Item No.	Part Number	Rating		Description
R401	QRD141J-222S	2.2 k Ω	1/4 W	Carbon
R402	QRD141J-222S	"	"	"
R403	QRD141J-104S	100 k Ω	"	"
R404	QRD141J-104S	"	"	"
R405	QRD141J-104S	"	"	"
R406	QRD141J-104S	"	"	"
R407	QRD141J-821S	820 Ω	"	"
R408	QRD141J-821S	"	"	"
R409	QRD141J-564S	560 k Ω	"	"
R410	QRD141J-564S	"	"	"
R411	QRD141J-683S	68 k Ω	"	"
R412	QRD141J-683S	"	"	"
R413	QRD141J-474S	470 k Ω	"	"
R414	QRD141J-474S	"	"	"
R415	QRD141J-513S	51 k Ω	"	"
R416	QRD141J-513S	"	"	"
R417	QRD141J-101S	100 Ω	"	"
R418	QRD141J-101S	"	"	"
R419	QRD141J-224S	220 k Ω	"	"

Resistors

Item No.	Part Number	Rating		Description
R420	QRD141J-224S	220 k Ω	1/4 W	Carbon
R421	QRD141J-471S	470 Ω	"	"
R422	QRD141J-471S	"	"	"
R423	QRG129J-681	680 Ω	1/2 W	Oxide Metal Film
R424	QRG129J-681	"	"	"
R425	QRD141J-102S	1 k Ω	1/4 W	Carbon
R426	QRD141J-102S	"	"	"
R451	QRD141J-472S	4.7 k Ω	"	"
R452	QRD141J-472S	"	"	"
R453	QRD141J-564S	560 k Ω	"	"
R454	QRD141J-564S	"	"	"
R455	QRD141J-153S	15 k Ω	"	"
R457	QRD141J-105S	1 M Ω	"	"
R458	QRD141J-105S	"	"	"
R461	QRD141J-334S	330 k Ω	"	"
R462	QRD141J-334S	"	"	"
R463	QRD141J-104S	100 k Ω	"	"
R465	QRD141J-102S	330 Ω	"	"
R466	QRD141J-102S	1 k Ω	"	"
R467	QRD141J-102S	"	"	"
R468	QRD141J-102S	"	"	"
R469	QRD141J-102S	"	"	"

Others

Item No.	Part Number	Rating		Description
	E03733-1202 E35530-001 E65377-001 E65419-001 52868-3			Socket Wire Ass'y Bracket (Source) C.B. Holder (EQ) L.E.D. Holder Terminal (GND)
	QSP0261-101 QSP0251-102 E03591-40D E03591-001			Push-switch (Function) Push-switch (Source) Pin Jack (PHONO, AUX, TAPE-2) Terminal Ass'y (TAPE-1)

9-(4) TAC-488A S.E.A. (Sound Effect Amp.) P. C. Board Ass'y

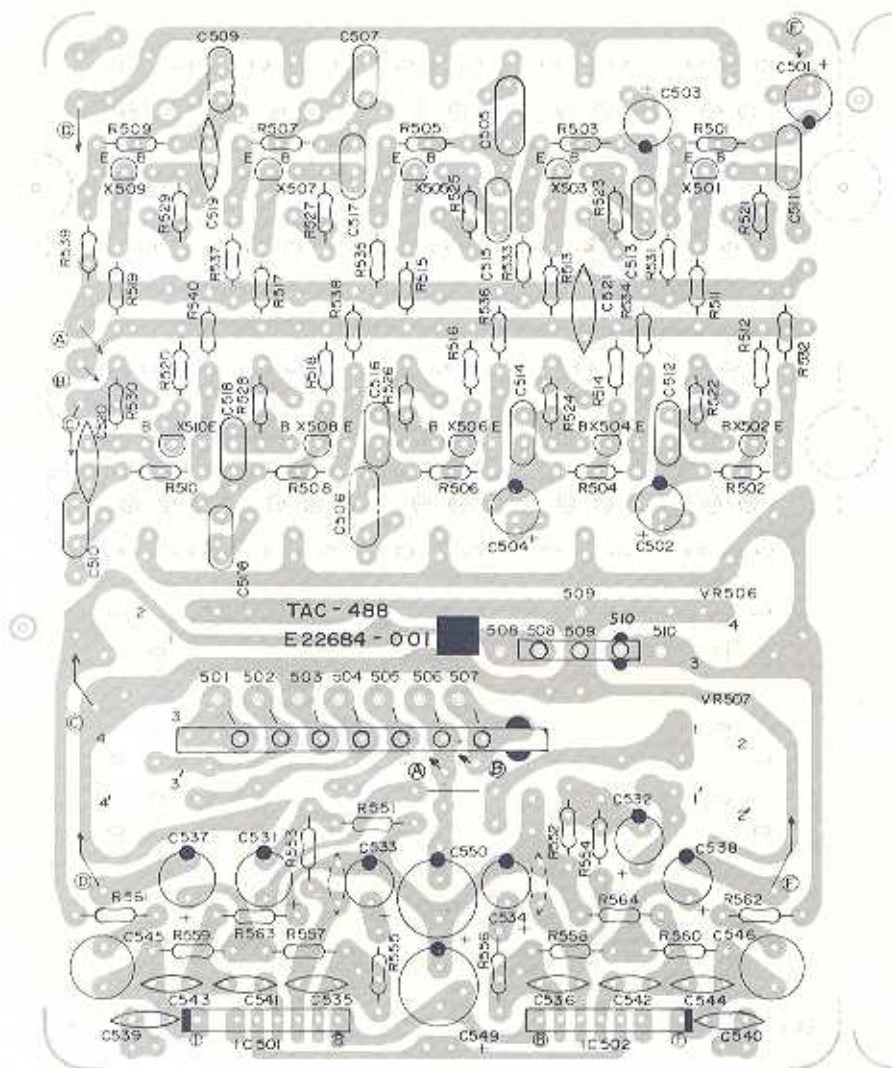

Fig. 28

Transistors

Item No.	Part Number	Rating		Description	Maker
		Pc	fT		
X501	2SC1775AV(F)	0.3 W	200 MHz	Silicon	Hitachi
X502	2SC1775AV(F)				
X503	2SC1775AV(F)				
X504	2SC1775AV(F)				
X505	2SC1775AV(F)				
X506	2SC1775AV(F)				
X507	2SC1775AV(F)				
X508	2SC1775AV(F)				
X509	2SC1775AV(F)				
X510	2SC1775AV(F)				

Integrated Circuits

Item No.	Part Number	Rating (Pc)	Description	Maker
IC501	HA1457	0.5 W	I.C.	Hitachi
IC502	HA1457	"	"	"

Capacitors

Item No.	Part Number	Rating		Description
C501	QEB51EM-475	4.7 μ F	25 V	Low Leak Current Electrolytic
C502	QEB51EM-475	"	"	"
C503	QEB51HM-474	0.47 μ F	50 V	"
C504	QEB51HM-474	"	"	"
C505	QFM31HK-124	0.12 μ F	"	Mylar
C506	QFM31HK-124	"	"	"
C507	QFM31HK-273	0.027 μ F	"	"
C508	QFM31HK-273	"	"	"
C509	QFM31HK-562	5600 pF	"	"
C510	QFM31HK-562	"	"	"
C511	QFM31HK-223	0.022 μ F	"	"
C512	QFM31HK-223	"	"	"
C513	QFM31HK-822	8200 pF	"	"
C514	QFM31HK-822	"	"	"
C515	QFM31HK-332	3300 pF	"	"
C516	QFM31HK-332	"	"	"
C517	QFM31HK-102	1000 pF	"	"
C518	QFM31HK-102	"	"	"
C519	QCS31HJ-681	680 pF	"	Ceramic
C520	QCS31HJ-681	"	"	"
C531	QEB51EM-475	4.7 μ F	25 V	Low Leak Current Electrolytic
C532	QEB51EM-475	"	"	"
C533	QEW51AA-476	47 μ F	10 V	Electrolytic
C534	QEW51AA-476	"	"	"
C535	QCS31HJ-101	100 pF	50 V	Ceramic
C536	QCS31HJ-101	"	"	"
C537	QEW51AA-476	47 μ F	10 V	Electrolytic
C538	QEW51AA-476	"	"	"
C539	QCS31HJ-820	82 pF	50 V	Ceramic
C540	QCS31HJ-820	"	"	"
C541	QCS31HJ-560	56 pF	"	"
C542	QCS31HJ-560	"	"	"
C543	QCS31HJ-271	270 pF	"	"
C544	QCS31HJ-271	"	"	"
C545	QEZ0046-475	4.7 μ F	"	Electrolytic
C546	QEZ0046-475	"	"	"
C549	QEW51EA-476	47 μ F	25 V	"
C550	QEW51EA-476	"	"	"

Resistors

Item No.	Part Number	Rating		Description
R501	QRD141J-122S	1.2 k Ω	1/4 W	Carbon
R502	QRD141J-122S	"	"	"
R503	QRD141J-122S	"	"	"
R504	QRD141J-122S	"	"	"
R505	QRD141J-122S	"	"	"
R506	QRD141J-122S	"	"	"
R507	QRD141J-122S	"	"	"
R508	QRD141J-122S	"	"	"
R509	QRD141J-122S	"	"	"
R510	QRD141J-122S	"	"	"
R511	QRD141J-391S	390 Ω	"	"
R512	QRD141J-391S	"	"	"
R513	QRD141J-391S	"	"	"
R514	QRD141J-391S	"	"	"
R515	QRD141J-391S	"	"	"
R516	QRD141J-391S	"	"	"
R517	QRD141J-391S	"	"	"

Resistors

Item No.	Part Number	Rating		Description
R518	QRD141J-391S	390 Ω	1/4 W	Carbon
R519	QRD141J-391S	"	"	"
R520	QRD141J-391S	"	"	"
R521	QRD141J-134S	130 k Ω	"	"
R522	QRD141J-134S	"	"	"
R523	QRD141J-913S	91 k Ω	"	"
R524	QRD141J-913S	"	"	"
R525	QRD141J-513S	51 k Ω	"	"
R526	QRD141J-513S	"	"	"
R527	QRD141J-333S	33 k Ω	"	"
R528	QRD141J-333S	"	"	"
R529	QRD141J-243S	24 k Ω	"	"
R530	QRD141J-243S	"	"	"
R531	QRD141J-682S	6.8 k Ω	"	"
R532	QRD141J-682S	"	"	"
R533	QRD141J-682S	"	"	"
R534	QRD141J-682S	"	"	"
R535	QRD141J-682S	"	"	"
R536	QRD141J-682S	"	"	"
R537	QRD141J-682S	"	"	"
R538	QRD141J-682S	"	"	"
R539	QRD141J-682S	"	"	"
R540	QRD141J-682S	"	"	"
R551	QRD141J-184S	180 k Ω	"	"
R552	QRD141J-184S	"	"	"
R553	QRD141J-102S	1 k Ω	"	"
R554	QRD141J-102S	"	"	"
R555	QRD141J-222S	2.2 k Ω	"	"
R556	QRD141J-222S	"	"	"
R557	QRD141J-682S	6.8 k Ω	"	"
R558	QRD141J-682S	"	"	"
R559	QRD141J-103S	10 k Ω	"	"
R560	QRD141J-103S	"	"	"
R561	QRD141J-562S	5.6 k Ω	"	"
R562	QRD141J-562S	"	"	"
R563	QRD141J-102S	1 k Ω	"	"
R564	QRD141J-102S	"	"	"

Others

Item No.	Part Number	Rating	Description
VR501	E35529-001	250 k Ω x 2	Bracket
	E65381-001		Felt
	QVZ5010-002		Slide Volume
	QVZ5010-002		"
VR502	QVZ5010-002	"	"
VR503	QVZ5010-002	"	"
VR504	QVZ5010-002	"	"
VR505	QVZ5010-002	"	"
VR506	QVT6C2W-6F5	250 k Ω (W)	"
VR507	QVT9C2B-5G5E	150 k Ω x 2 (B)	"

9-(5) TFM914GUA1 FM/AM Tuner P. C. Board Ass'y

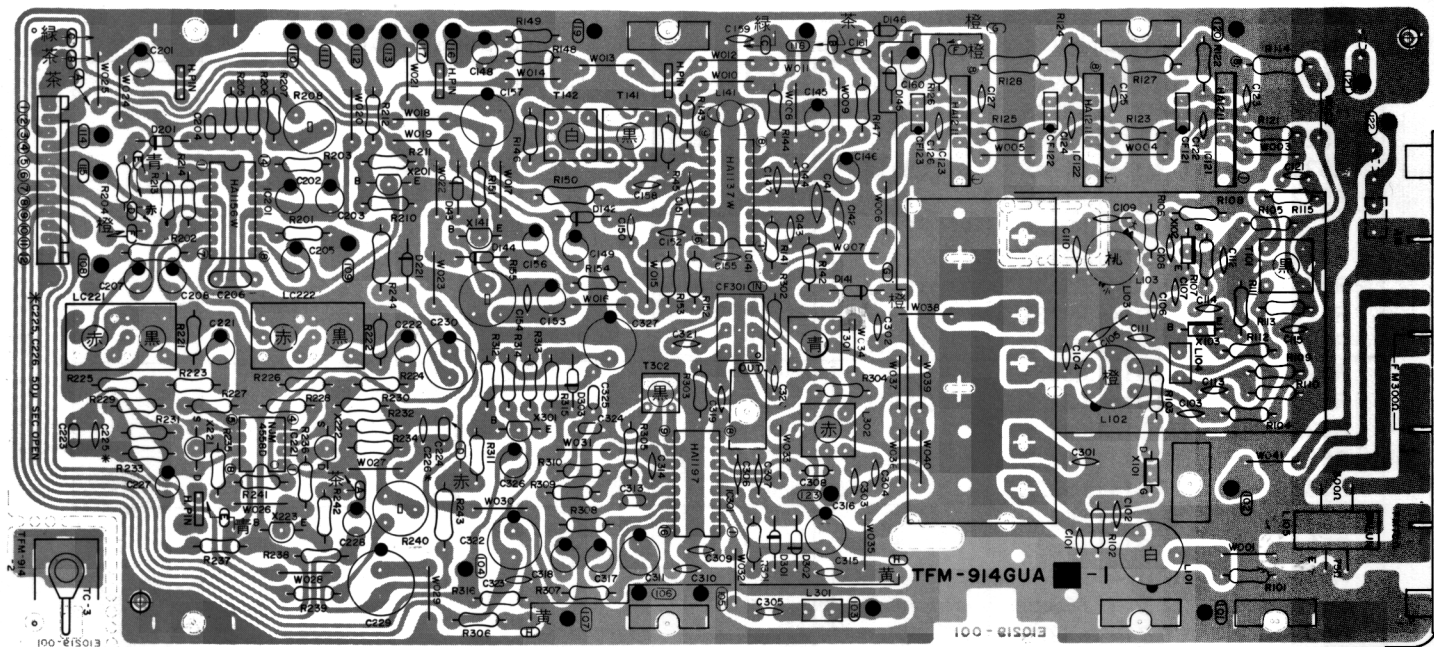

Fig. 29

Transistors

Item No.	Part Number	Rating		Description	Maker
		Pc	fT		
X101	2SK55D	0.15 W	100 MHz	F.E.T.	Hitachi
X102	2SC1342(B, C)	0.1 W	250 MHz	Silicon	"
X103	2SC535(C)	"	940 MHz	"	"
X141	2SC458(C)	0.2 W	230 MHz	"	"
X201	2SC458(C)	"	"	"	"
X221	2SK68(M, N)	0.25 W	"	F.E.T.	NEC
X222	2SK68 (M, N)	"	"	"	"
X223	2SA872AV(E)	0.3 W	120 MHz	Silicon	Hitachi
X301	2SC458(C)	0.2 W	230 MHz	"	"

Integrated Circuits

Item No.	Part Number	Rating (Pc)		Description	Maker
IC121	HA1211	0.2 W		I.C.	Hitachi
IC122	HA1211	"		"	"
IC123	HA1211	"		"	"
IC141	HA1137W	0.55 W		"	"
IC201	HA1156W	0.4 W		"	"
IC221	NJM4558D	0.5 W		"	JRC
IC301	HA1197	0.45 W		"	Hitachi

Diodes

Item No.	Part Number	Rating		Description	Maker
D141	1S2473			Silicon	Toyo Dengu
D142	1S2473			"	"
D143	1S2473			"	"
D144	1S2473			"	"
D145	1S2473			"	"
D146	1S2473			"	"
D201	1S2473			"	"
D221	XZ-132	0.5 W	(13 Volt)	Zener	JRC
D301	1S2473			Silicon	Toyo Dengu
D302	1S2473			"	"
D303	1S2473			"	"

Coils & Transformers

Item No.	Part Number	Rating		Description
L101	E03477-031			RF Coil
L102	E03477-35			"
L103	E03477-026			OSC Coil
L104	E03522-1R5KY			Choke Coil
L105	E03177-001			Balun Coil
L141	E03746-220J			Choke Coil
L301	E03522-2R2KY			"
L302	E03079-29			AM OSC Coil
T101	E03078-39			FM IFT
T141	E03078-43			Detector Transformer
T142	E03078-44			"
T301	E03613-009			AM IFT
T302	E03062-36			"

Capacitors

Item No.	Part Number	Rating		Description
C101	QCS31HJ-150	15 pF	50 V	Ceramic
C102	QCS31HJ-330Z	33 pF	"	"
C103	QCF31HP-103ZU	0.01 μ F	"	"
C104	QCS31HJ-180Z	18 pF	"	"
C105	QCS11HJ-4R0	4 pF	"	"
C106	QCS31HJ-4R0	"	"	"
C107	QCT05CH-100	10 pF	"	"
C108	QCT05CH-220	22 pF	"	"
C109	QCT05CH-7R0	7 pF	"	"
C110	QCT05PH-220	22 pF	"	"
C111	QCS31HJ-3R0Z	3 pF	"	"
C112	QCF31HP-103ZU	0.01 μ F	50 V	"
C113	QCS31HJ-151Z	150 pF	"	"
C114	QCF31HP-103U	0.01 μ F	"	"
C115	QCF31HP-103ZU	"	"	"
C121	QCF31HP-223Z	0.022 μ F	"	"
C122	QCF31HP-223Z	"	"	"
C123	QCF31HP-223Z	"	"	"
C124	QCF31HP-223Z	"	"	"
C125	QCF31HP-223Z	"	"	"
C126	QCF31HP-223Z	"	"	"
C127	QCF31HP-223Z	"	"	"
C141	QCZ0107-473	0.047 μ F	"	"
C142	QCZ0107-473	"	"	"
C143	QCF31HP-223Z	0.022 μ F	50 V	"
C144	QCF31HP-223	"	"	"
C145	QEW61HA-105Z	1 μ F	"	Electrolytic
C146	QEW61EA-475Z	4.7 μ F	25 V	"
C147	QCS31HJ-330Z	33 pF	50 V	Ceramic
C148	QEW61EA-475Z	4.7 μ F	25 V	Electrolytic
C149	QEW61HA-105Z	1 μ F	50 V	"
C150	QCF31HP-223Z	0.022 μ F	"	Ceramic
C151	QCF31HP-223	"	"	"
C152	QCF31HP-223Z	"	"	"
C153	QEW51HA-474	0.47 μ F	"	Electrolytic
C154	QCF31HP-223Z	0.022 μ F	"	Ceramic
C155	QCF31HP-223Z	"	"	"
C156	QEW51AA-476	47 μ F	10 V	Electrolytic
C157	QEW51CA-107	100 μ F	16 V	"
C158	QCF31HP-223Z	0.022 μ F	50 V	Ceramic
C159	QCF31HP-223Z	"	"	"
C160	QEW61CA-106Z	10 μ F	16 V	Electrolytic
C161	QCF31HP-223Z	0.022 μ F	50 V	Ceramic
C162	QEW50JA-477	470 μ F	6.3 V	Electrolytic

Capacitors

Item No.	Part Number	Rating		Description
C201	QEW61CA-106Z	10 μ F	16 V	Electrolytic
C202	QEB51HM-224	0.22 μ F	50 V	Low Leak Current Electrolytic
C203	QEB51EM-106	10 μ F	25 V	"
C204	QFP31HJ-471	470 pF	50 V	Polypropylene
C205	QEB51HM-105	1 μ F	"	Low Leak Current Electrolytic
C206	QFM31HK-473	0.047 μ F	"	Mylar
C207	QEW61EA-475Z	4.7 μ F	25 V	Electrolytic
C208	QEW51EA-475	"	"	"
C221	QEW61EA-475Z	"	"	"
C222	QEW61EA-475Z	"	"	"
C223	QFP31HG-102	1000 pF	50 V	Polypropylene
C224	QFP31HG-102	"	"	"
C225	QFP31HJ-511	510 pF	"	"
C226	QFP31HJ-511	"	"	"
C227	QEW51EA-475	4.7 μ F	25 V	Electrolytic
C228	QEW61EA-475Z	"	"	"
C229	QEW51CA-477	470 μ F	16 V	"
C230	QEW51CA-107	100 μ F	"	"
C231	QFM31HK-104	0.01 μ F	50 V	Mylar
C301	QCS31HJ-3R0Z	3 pF	50 V	Ceramic
C302	QCS31HJ-150Z	15 pF	"	"
C303	QFP31HG-301	300 pF	"	Polypropylene
C304	QCS31HJ-220Z	22 pF	"	Ceramic
C305	QCF31HP-223Z	0.022 μ F	"	"
C306	QCF31HP-223	"	"	"
C307	QCF31HP-223	"	"	"
C308	QFM41HK-103	0.01 μ F	"	Mylar
C309	QCF31HP-223Z	0.022 μ F	"	Ceramic
C310	QCZ0107-473	0.047 μ F	"	"
C311	QEW61AA-476Z	47 μ F	10 V	Electrolytic
C313	QFM31HK-102Z	1000 pF	50 V	Mylar
C314	QCF31HP-223Z	0.022 μ F	"	Ceramic
C315	QCF31HP-223Z	"	"	"
C316	QEW51CA-476	47 μ F	16 V	Electrolytic
C317	QEW51HA-105	1 μ F	50 V	"
C318	QEW61CA-106Z	10 μ F	16 V	"
C319	QCF31HP-223	0.022 μ F	50 V	Ceramic
C320	QCS31HJ-101Z	100 pF	"	"
C321	QCS31HJ-101Z	"	"	"
C322	QEW51CA-107	100 μ F	16 V	Electrolytic
C323	QCF31HP-223Z	0.022 μ F	50 V	Ceramic
C324	QFM31HK-562Z	5600 pF	"	Mylar
C325	QFM31HK-473	0.047 μ F	"	"
C326	QEW61HA-474Z	0.47 μ F	"	Electrolytic
C327	QEW51CA-107	100 μ F	16 V	"

Resistors

Item No.	Part Number	Rating		Description
R102	QRD141J-105S	1 M Ω	1/4 W	Carbon
R103	QRD141J-470S	47 Ω	"	"
R104	QRD141J-101S	100 Ω	"	"
R105	QRD141J-561S	560 Ω	"	"
R106	QRD141J-222S	2.2 k Ω	"	"
R107	QRD141J-103S	10 k Ω	"	"
R108	QRD141J-103S	10 k Ω	"	"
R109	QRD141J-223S	22 k Ω	"	"
R110	QRD141J-472S	4.7 k Ω	"	"
R111	QRD141J-102S	1 k Ω	"	"
R112	QRD141J-101S	100 Ω	"	"
R114	QRX129J-100	10 Ω	1/2 W	Oxide Metal Film

Resistors

Item No.	Part Number	Rating		Description
R115	QRD141J-101S	100 Ω	1/4 W	Carbon
R121	QRD141J-471S	470 Ω	"	"
R122	QRD141J-331S	330 Ω	"	"
R123	QRD141J-331S	"	"	"
R124	QRD141J-331S	"	"	"
R125	QRD141J-331S	"	"	"
R126	QRD141J-331S	"	"	"
R127	QRX129J-100	10 Ω	1/2 W	Oxide Metal Film
R128	QRX129J-100	"	"	"
R141	QRD141J-331S	330 Ω	1/4 W	Carbon
R142	QRD141J-682S	6.8 k Ω	"	"
R143	QRD141J-103S	10 k Ω	"	"
R144	QRD141J-391S	390 Ω	"	"
R145	QRD141J-123S	12 k Ω	"	"
R146	QRD141J-222S	2.2 k Ω	"	"
R147	QRD141J-123S	12 k Ω	"	"
R148	QRD141J-223S	22 k Ω	"	"
R149	QRD141J-473S	47 k Ω	"	"
R150	QRX129J-100	10 Ω	1/2 W	Oxide Metal Film
R151	QRD141J-103S	10 k Ω	1/4 W	Carbon
R152	QRD141J-104S	100 k Ω	"	"
R153	QRD141J-332S	3.3 k Ω	"	"
R154	QRD141J-123S	12 k Ω	"	"
R155	QVP4A0B-473	47 k Ω	"	Variable
R201	QRD141J-105S	1 M Ω	1/4 W	Carbon
R202	QRG129J-221	220 Ω	1/2 W	Oxide Metal Film
R203	QRD141J-102S	1 k Ω	1/4 W	Carbon
R204	QRD141J-332S	3.3 k Ω	"	"
R205	QRD141J-183S	18 k Ω	"	"
R206	QRD141J-474S	470 k Ω	"	"
R207	QRD141J-153S	15 k Ω	"	"
R208	QVP4A0B-472	4.7 k Ω	"	Variable
R210	QRD141J-223S	22 k Ω	1/4 W	Carbon
R211	QRD141J-563S	56 k Ω	"	"
R212	QRD141J-333S	33 k Ω	"	"
R213	QRD141J-472S	4.7 k Ω	"	"
R214	QRD141J-472S	"	"	"
R221	QRD141J-333S	33 k Ω	"	"
R222	QRD141J-333S	"	"	"
R223	QRD141J-472S	4.7 k Ω	"	"
R224	QRD141J-472S	"	"	"
R225	QRD141J-333S	33 k Ω	"	"
R226	QRD141J-333S	"	"	"
R227	QRD141J-102S	1 k Ω	"	"
R228	QRD141J-102S	"	"	"
R229	QRD141J-471S	470 Ω	"	"
R230	QRD141J-471S	"	"	"
R231	QRD141J-104S	100 k Ω	"	"
R232	QRD141J-104S	"	"	"
R233	QRD141J-913S	91 k Ω	"	"
R234	QRD141J-913S	"	"	"
R235	QRD141J-184S	180 k Ω	"	"
R236	QRD141J-184S	"	"	"
R237	QRD141J-473S	47 k Ω	"	"
R238	QRD141J-473S	"	"	"
R239	QRD141J-272S	2.7 k Ω	"	"
R240	QVP4A0B-103	10 k Ω	"	Variable
R241	QRD141J-184S	180 k Ω	1/4 W	Carbon
R242	QRD141J-183S	18 k Ω	"	"
R243	QRG129J-560	56 Ω	1/2 W	Oxide Metal Film
R244	QRG129J-222	2.2 k Ω	"	"

Resistors

Item No.	Part Number	Rating		Description
R301	QRD141J-152S	1.5 k Ω	1/4 W	Carbon
R302	QRD141J-103S	10 k Ω	"	"
R303	QRD141J-272S	2.7 k Ω	"	"
R304	QRD141J-561S	560 Ω	"	"
R305	QRD141J-331S	330 Ω	"	"
R306	QRD141J-151S	150 Ω	"	"
R307	QRD141J-681S	680 Ω	"	"
R308	QRD141J-103S	10 k Ω	"	"
R309	QRD141J-103S	"	"	"
R310	QRD141J-472S	4.7 k Ω	"	"
R311	QRD141J-224S	220 k Ω	"	"
R312	QRD141J-683S	68 k Ω	"	"
R313	QRD141J-222S	2.2 k Ω	"	"
R314	QRD141J-472S	4.7 k Ω	"	"
R315	QRD141J-102S	1 k Ω	"	"
R316	QRD141J-473S	47 k Ω	"	"

Others

Item No.	Part Number	Rating	Description
	E03572-007C E03732-012A E03757-001 E33535-004 E49784-002		Antenna Terminal 12 Pins Plug Variable Tuning Capacitor Shield Cover Connect Pin
TC3	QAT3001-005		Trimmer
CF121	E03357-008		Ceramic Filter
CF122	E03357-008		"
CF123	E03357-008		"
CF301	E03613-008		AM Ceramic Filter
LC221	E03427-013		Low Pass Filter
LC222	E03427-013		"

} These filters must be used in the same rank. The kit number of these filters is PC016. Please order in this kit number.

NOTE

FM DE-EMPHASIS Network (TFM914GUA1)

Item No.	Part Number	
	75 μ sec	50 μ sec
C223	QFP31HG-102	QFP31HG-102
C224	QFP31HG-102	QFP31HG-102
C225	QFP31HJ-511	Open
C226	QFP31HJ-511	Open

TUNER IC VOLTAGE

IC NO.	IC NAME	PIN NO.	1	2	3	4	5	6	7	8	9	10	11	12	13	14	15	16	SWITCH POSITION
IC 181	HA1137M	2.0	2.0	2.0	0.0	0.5	5.5	5.5	5.5	5.5	5.5	12.0	4.7	0.2	0	4.8	0	FM	
IC 201	HA1156W	11.4	3.0	5.4	8.5	8.5	10.7	0	0.0	2.3	1.5	2.2	2.3	3.2				FM	
IC 221	HJM4558D	0.0	0.0	0.0	13.0	0.0	0.0	0.0	11.4									FM	
IC 301	HA1197	5.1	2.2	11.8	0.0	11.3	3.7	1.3	2.0	8.6	0	12.4	1.5	0.7	1.4	0.0	1.0	AM	

IC NO.	IC NAME	PIN NO.	1	2	3	4	5
IC 121	HA 1211					1.5	1.1
IC 122	HA 1211					1.5	1.1
IC 123	HA 1211					1.5	1.1

VOLTAGES:
THESE VOLTAGES ARE MEASURED WITH DC VTVM
AT NONSIGNAL INPUT

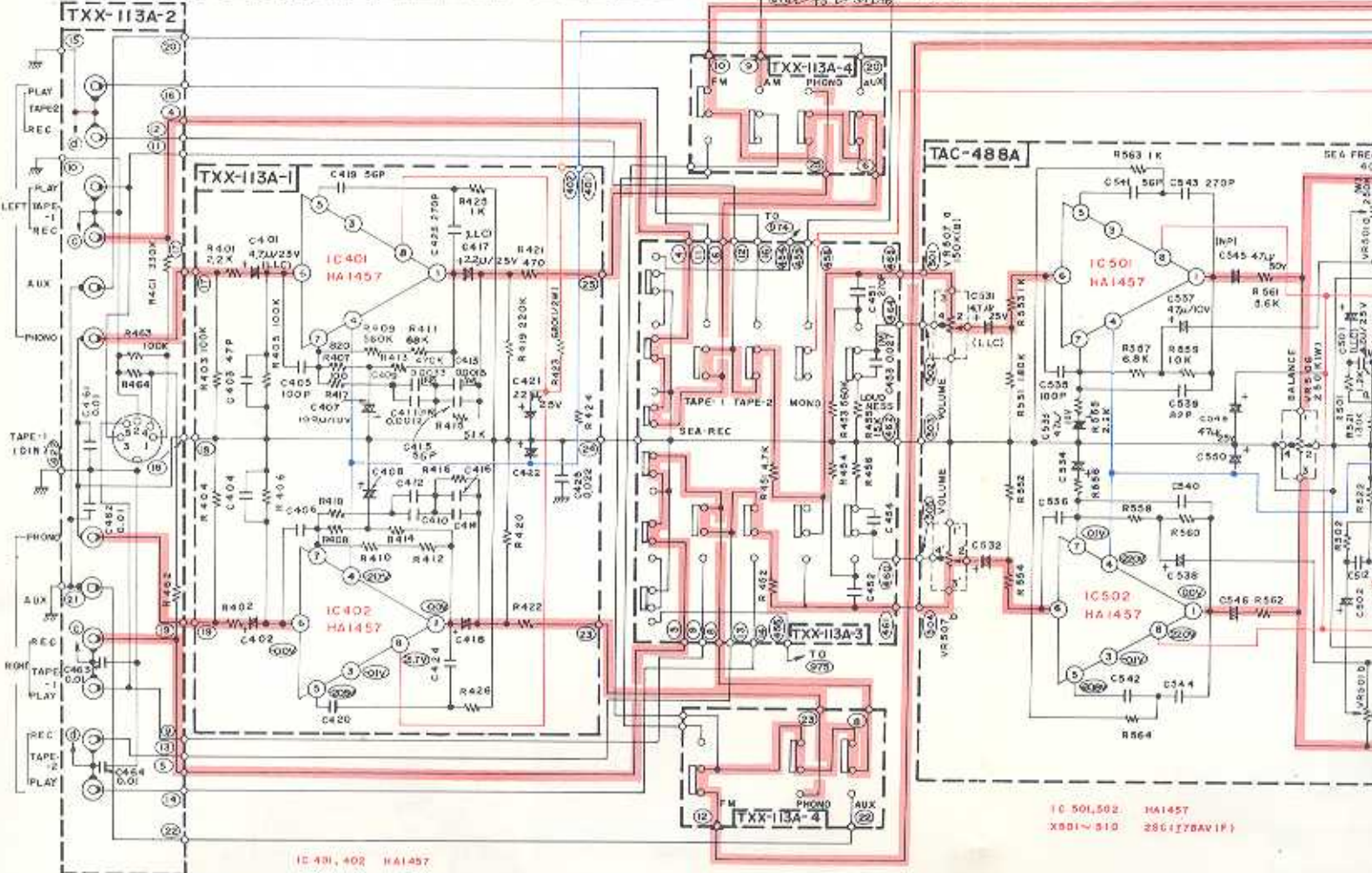
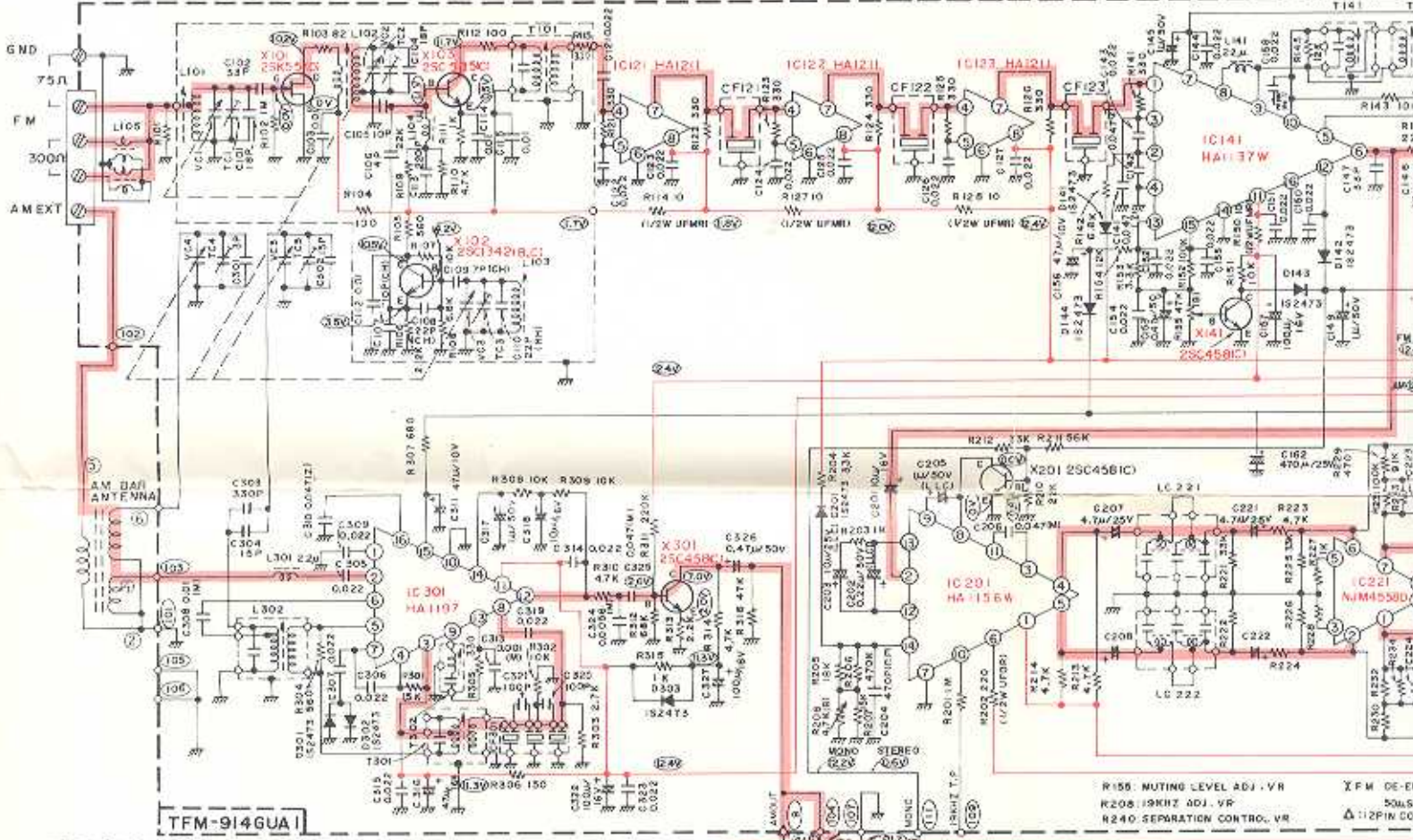

1	2	3	4	5	6	7	8	9	10
1.5	1.5	0	11.1	11.8	12.0	12.2	12.4	12.6	12.8

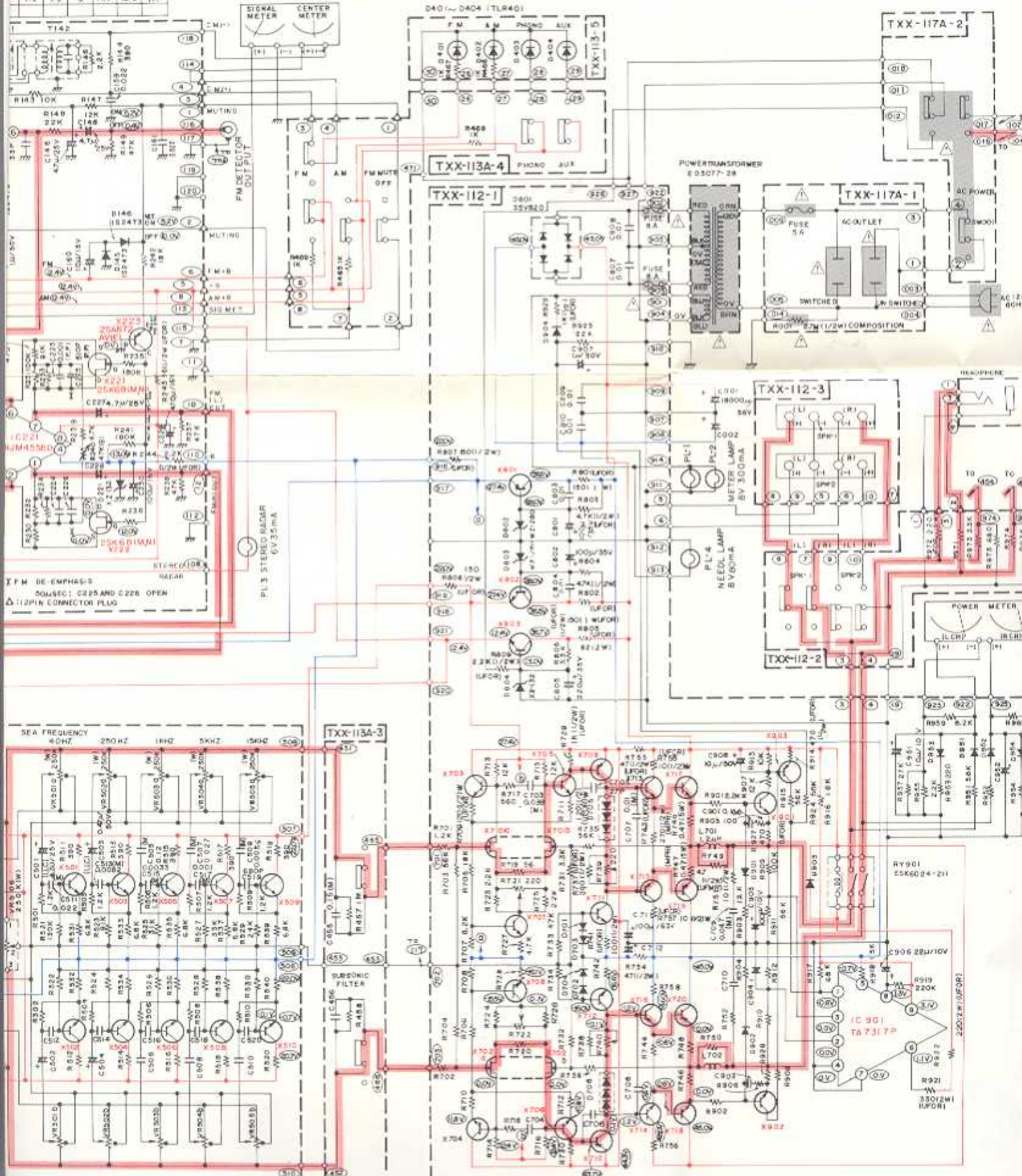

FM DE-EMPHASIS SOURCE: C225 AND C226 OPEN 112PIN CONNECTOR PUG

R721, R722: CENTER VOLTAGE ADJ. VR. R739, R740: IDLING CURRENT ADJ. VR.

- X700.702 MPA63H(1)
- X700.708 20C172AV(F)
- X709.710 23A839(B.V)
- X711.712 23C190A(S.V)
- X90L902
- X90S
- 0901 ~ 904
- IC301 7AT517P
- 23U729AV(F)
- 23A873AV(B)
- 182473
- 7AT517P

CAUTION TABLE

Apply to:	Serial Number:	Part Number:	Rating:	Part Number:	Rating:
	0001-02000	0001-02000		0001-02000	
		02001-02000		02001-02000	
		02001-02000		02001-02000	
		02001-02000		02001-02000	
		02001-02000		02001-02000	